

8" Benchtop Jointer with Helical-Style Cutterhead



Operator's Manual

Record the serial number and date of purchase in your manual for future reference.

The serial number can be found on the specification label on the rear of your machine.

Serial Number: _____ Date of purchase: _____

For technical support, email techsupport@rikontools.com - For parts questions, email parts@rikontools.com

TABLE OF CONTENTS

Specifications.....	2
Safety Instructions	3 - 6
Getting To Know Your Machine	7
Contents of Package	7 - 8
Installation	8
Assembly	9 - 11
Operation	12 - 13
Adjustments.....	14 - 18
Maintenance	19
Electricals & Wiring Diagram	5 & 19
Parts Diagrams & Parts Lists	20 - 22
Warranty	22
Troubleshooting	23

SPECIFICATIONS

Motor	120V, 60Hz, 10A, PH1, AC
Motor Speed (no load).....	20,000 RPM
Cutterhead Diameter	2" (50.80mm)
Cutterhead Speed	12,000 RPM
Number of Carbide Knife Inserts, 2-sided.....	16
Knife Insert Size (LxWxT)	0.56" x 0.56" x 0.077" (14.2 x 14.2 x 2mm)
Number of Cutterhead Insert Rows	6
Maximum Depth of Cut	1/8" (3mm)
Maximum Cutting Width	8" (203.20mm)
Minimum Length of Stock	10" (254mm)
Minimum Width of Stock	3/4" (19mm)
Minimum Thickness of Stock	1/2" (13mm)
Table Size (2) (LxW)	14-1/4" x 8-3/16" (368.30 x 207.96mm)
Overall Table Size (LxW)	30-1/2" x 8-3/16" (774.70 x 207.96mm)
Overall Table Size w/Extensions (LxW)	51-1/2" x 8-3/16" (1,308.10 x 207.96mm)
Fence Size (LxW)	19-3/4" x 4-3/8" (501.65 x 111.13mm)
Fence Tilt	90° to 135°
Dust Port (O.D.).....	4" & 2-1/2" (101.60 x 63.50mm)
Dust Collection Minimum CFM	100
Noise Level (no load)	≤ 100 dB
Overall Size (LxWxH).....	51-1/2" x 18-3/4" x 13" (1,308.10 x 476.25 x 330.20mm)
Base Size (LxW).....	19" x 11-1/4" (482.60 x 285.75mm)
Net Weight	49 lbs (22.23kg)

NOTE: The specifications, photographs, drawings and information in this manual represent the current model when the manual was prepared. Changes and improvements may be made at any time, with no obligation on the part of Rikon Power Tools, Inc. to modify previously delivered units. Reasonable care has been taken to ensure that the information in this manual is correct, to provide you with the guidelines for the proper safety, assembly and operation of this machine.

SAFETY INSTRUCTIONS

IMPORTANT! Safety is the single most important consideration in the operation of this equipment. **The following instructions must be followed at all times.** Failure to follow all instructions listed below may result in electric shock, fire, and/or serious personal injury.

There are certain applications for which this tool was designed. We strongly recommend that this tool not be modified and/or used for any other application other than that for which it was designed. If you have any questions about its application, do not use the tool until you have contacted us and we have advised you.

SAFETY SYMBOLS



SAFETY ALERT SYMBOL: Indicates DANGER, WARNING, or CAUTION. This symbol may be used in conjunction with other symbols or pictographs.



Indicates an imminently hazardous situation, which, if not avoided, could result in death or serious injury.



Indicates a potentially hazardous situation, which, if not avoided, could result in death or serious injury.



Indicates a potentially hazardous situation, which, if not avoided, could result in minor or moderate injury.

NOTICE: Shown without Safety Alert Symbol indicates a situation that may result in property damage.

GENERAL SAFETY

KNOW YOUR POWER TOOL. Read the owner's manual carefully. Learn the tool's applications, work capabilities, and its specific potential hazards.

BEFORE USING YOUR MACHINE

To avoid serious injury and damage to the tool, read and follow all of the Safety and Operating Instructions before operating the machine.

1. **WARNING:** Some dust created by using power tools contains chemicals known to the State of California to cause cancer, birth defects, or other reproductive harm. Some examples of these chemicals are:

- Lead from lead-based paints.
- Crystalline silica from bricks, cement, and other masonry products.
- Arsenic and chromium from chemically treated lumber.

Your risk from these exposures varies, depending on how often you do this type of work. To reduce your exposure to these chemicals: work in a well ventilated area and work with approved safety equipment, such as those dust masks that are specially designed to filter out microscopic particles.

2. **READ** the entire Owner's Manual. **LEARN** how to use the tool for its intended applications.

3. **GROUND ALL TOOLS.** If the tool is supplied with a 3 prong plug, it must be plugged into a 3-contact electrical receptacle. The 3rd prong is used to ground the tool and provide protection against accidental electric shock. **DO NOT** remove the 3rd prong. See Grounding Instructions on the following pages.

4. **AVOID A DANGEROUS WORKING ENVIRONMENT.** **DO NOT** use electrical tools in a damp environment or expose them to rain.

5. **DO NOT** use electrical tools in the presence of flammable liquids or gases.

6. **ALWAYS** keep the work area clean, well lit, and organized. **DO NOT** work in an environment with floor surfaces that are slippery from debris, grease, and wax.

7. **KEEP VISITORS AND CHILDREN AWAY. DO NOT** permit people to be in the immediate work area, especially when the electrical tool is operating.

8. **DO NOT FORCE THE TOOL** to perform an operation for which it was not designed. It will do a safer and higher quality job by only performing operations for which the tool was intended.

9. **WEAR PROPER CLOTHING. DO NOT** wear loose clothing, gloves, neckties, or jewelry. These items can get caught in the machine during operations and pull the operator into the moving parts. The user must wear a protective cover on their hair, if the hair is long, to prevent it from contacting any moving parts.

10. **CHILDPROOF THE WORKSHOP AREA** by removing switch keys, unplugging tools from the electrical receptacles, and using padlocks.

11. **ALWAYS UNPLUG THE TOOL FROM THE ELECTRICAL RECEPTACLE** when making adjustments, changing parts or performing any maintenance.

SAFETY INSTRUCTIONS

12. KEEP PROTECTIVE GUARDS IN PLACE AND IN WORKING ORDER.

13. AVOID ACCIDENTAL STARTING. Make sure that the power switch is in the “OFF” position before plugging in the power cord to the electrical receptacle.

14. REMOVE ALL MAINTENANCE TOOLS from the immediate area prior to turning “ON” the machine.

15. USE ONLY RECOMMENDED ACCESSORIES. Use of incorrect or improper accessories could cause serious injury to the operator and cause damage to the tool. If in doubt, check the instruction manual that comes with that particular accessory.

16. NEVER LEAVE A RUNNING TOOL UNATTENDED. Turn the power switch to the “OFF” position. **DO NOT** leave the tool until it has come to a complete stop.

17. DO NOT STAND ON A TOOL. Serious injury could result if the tool tips over, or you accidentally contact the tool.

18. DO NOT store anything above or near the tool where anyone might try to stand on the tool to reach it.

19. MAINTAIN YOUR BALANCE. DO NOT extend yourself over the tool. Wear oil resistant rubber soled shoes. Keep floor clear of debris, grease, and wax.

20. MAINTAIN TOOLS WITH CARE. Always keep tools clean and in good working order. Keep all blades and tool bits sharp, dress grinding wheels and change other abrasive accessories when worn.

21. EACH AND EVERY TIME, CHECK FOR DAMAGED PARTS PRIOR TO USING THE TOOL. Carefully check all guards to see that they operate properly, are not damaged, and perform their intended functions. Check for alignment, binding or breaking of moving parts. A guard or other part that is damaged should be immediately repaired or replaced.

22. DO NOT OPERATE TOOL WHILE TIRED, OR UNDER THE INFLUENCE OF DRUGS, MEDICATION OR ALCOHOL.

23. SECURE ALL WORK. Use clamps or jigs to secure the work piece. This is safer than attempting to hold the work piece with your hands.

24. STAY ALERT, WATCH WHAT YOU ARE DOING, AND USE COMMON SENSE WHEN OPERATING A POWER TOOL.

A moment of inattention while operating power tools may result in serious personal injury.

25. ALWAYS WEAR A DUST MASK TO PREVENT INHALING DANGEROUS DUST OR AIRBORNE PARTICLES, including wood dust, crystalline silica dust and asbestos dust. Direct particles away from face and body. Always operate tool in well ventilated area and provide for proper dust removal. Use dust collection system wherever possible. Exposure to the dust may cause serious and permanent respiratory or other injury, including silicosis (a serious lung disease), cancer, and death. Avoid breathing the dust, and avoid prolonged contact with dust. Allowing dust to get into your mouth or eyes, or lay on your skin may promote absorption of harmful material. Always use properly fitting NIOSH/OSHA approved respiratory protection appropriate for the dust exposure, and wash exposed areas with soap and water.

26. USE A PROPER EXTENSION CORD IN GOOD CONDITION. When using an extension cord, be sure to use one heavy enough to carry the current your product will draw. The table on the following page shows the correct size to use depending on cord length and nameplate amperage rating. If in doubt, use the next heavier gauge. The smaller the gauge number, the larger diameter of the extension cord. If in doubt of the proper size of an extension cord, use a shorter and thicker cord. An undersized cord will cause a drop in line voltage resulting in a loss of power and overheating.
USE ONLY A 3-WIRE EXTENSION CORD THAT HAS A 3-PRONG GROUNDING PLUG AND A 3-POLE RECEPTACLE THAT ACCEPTS THE TOOL’S PLUG.

27. ADDITIONAL INFORMATION regarding the safe and proper operation of this product is available from:

- Power Tool Institute
1300 Summer Avenue
Cleveland, OH 44115-2851
www.powertoolinstitute.org
- National Safety Council
1121 Spring Lake Drive
Itasca, IL 60143-3201
www.nsc.org
- American National Standards Institute
25 West 43rd Street, 4th Floor
New York, NY 10036
www.ansi.org
- ANSI 01.1 Safety Requirements for Woodworking Machines and the U.S. Department of Labor regulations
www.osha.gov

28. SAVE THESE INSTRUCTIONS. Refer to them frequently and use them to instruct others.

SAFETY INSTRUCTIONS

ELECTRICAL SAFETY

⚠ WARNING: THIS TOOL MUST BE GROUNDED WHILE IN USE TO PROTECT THE OPERATOR FROM ELECTRIC SHOCK.

IN THE EVENT OF A MALFUNCTION OR BREAKDOWN, grounding provides the path of least resistance for electric current and reduces the risk of electric shock. This tool is equipped with an electric cord that has an equipment grounding conductor and requires a grounding plug (not included). The plug **MUST** be plugged into a matching electrical receptacle that is properly installed and grounded in accordance with **ALL** local codes and ordinances.

DO NOT MODIFY ANY PLUG. If it will not fit the electrical receptacle, have the proper electrical receptacle installed by a qualified electrician.

IMPROPER ELECTRICAL CONNECTION of the equipment grounding conductor can result in risk of electric shock. The conductor with the green insulation (with or without yellow stripes) is the equipment grounding conductor. **DO NOT** connect the equipment grounding conductor to a live terminal if repair or replacement of the electric cord or plug is necessary.

CHECK with a qualified electrician or service personnel if you do not completely understand the grounding instructions, or if you are not sure the tool is properly grounded when installing or replacing a plug.

USE ONLY A 3-WIRE EXTENSION CORD THAT HAS THE PROPER TYPE OF A 3-PRONG GROUNDING PLUG THAT MATCHES THE MACHINE'S 3-PRONG PLUG AND ALSO THE 3-POLE RECEPTACLE THAT ACCEPTS THE TOOL'S PLUG. *

REPLACE A DAMAGED OR WORN CORD IMMEDIATELY.

This tool is intended for use on a circuit that has an electrical receptacle as shown in **FIGURE A**. It shows a 3-wire electrical plug and electrical receptacle that has a grounding conductor. If a properly grounded electrical receptacle is not available, an adapter as shown in **FIGURE B** can be used to temporarily connect this plug to a 2-contact ungrounded receptacle. The adapter has a rigid lug extending from it that **MUST** be connected to a permanent earth ground, such as a properly grounded receptacle box. **THIS ADAPTER IS PROHIBITED IN CANADA.**

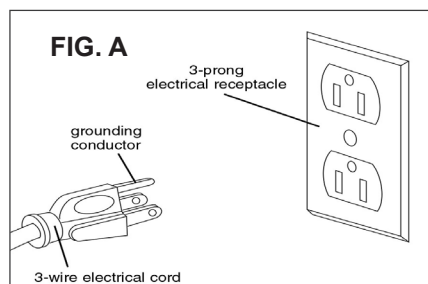

EXTENSION CORDS

⚠ WARNING: THE USE OF AN EXTENSION CORD WITH THIS MACHINE IS NOT RECOMMENDED. For best power and safety, plug the machine directly into a dedicated, grounded electrical outlet that is within the supplied cord length of the machine.

If an extension cord needs to be used, it should only be for a limited operation of the machine. The extension cord should be as short as possible in length, and have a minimum gauge size of 14AWG.

⚠ WARNING: Check extension cords before each use. If damaged replace immediately. Never use a tool with a damaged cord, since touching the damaged area could cause electrical shock, resulting in serious injury.

Use a proper extension cord. Only use cords listed by Underwriters Laboratories (UL). Other extension cords can cause a drop in line voltage, resulting in a loss of power and overheating of tool. When operating a power tool outdoors, use an outdoor extension cord marked "W-A" or "W". These cords are rated for outdoor use and reduce the risk of electric shock.

MINIMUM RECOMMENDED GAUGE FOR EXTENSION CORDS (AWG)

120 VOLT OPERATION ONLY				
	25' LONG	50' LONG	100' LONG	150' LONG
0 to 6 Amps	18 AWG	16 AWG	16 AWG	14 AWG
6 to 10 Amps	18 AWG	16 AWG	14 AWG	12 AWG
10 to 12 Amps	16 AWG	16 AWG	14 AWG	12 AWG

⚠ WARNING: Keep the extension cord clear of the working area. Position the cord so that it will not get caught on lumber, tools or other obstructions while you are working with your power tool.

* Canadian electrical codes require extension cords to be certified SJT type or better.

** The use of an adapter in Canada is not acceptable.

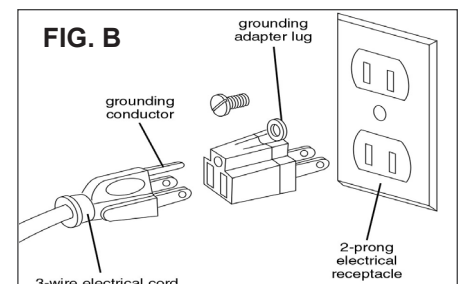

SAFETY INSTRUCTIONS

SPECIFIC SAFETY INSTRUCTIONS FOR JOINTERS

This machine is intended for the surfacing of natural, solid woods. The permissible workpiece dimensions must be observed (see Technical Specification). Any other use not as specified, including modification of the machine or use of parts not tested and approved by the equipment manufacturer can cause unforeseen damage and invalidate the warranty.

ATTENTION: Use of this jointer still presents risks that cannot be eliminated by the manufacturer. Therefore, the user must be aware that wood working machines are dangerous if not used with care and all safety precautions are adhered to.

1. Do not operate this machine until you have read all of the following instructions.
2. Do not attempt to operate this machine until it is completely assembled and properly grounded.
3. Do not turn ON this machine if any pieces are damaged or missing.
4. If you are not familiar with the operation of the machine, obtain assistance from a qualified person.
5. Always wear approved, safety protective eye wear and hearing protection when operating this machine.
6. Always wear a dust mask and use adequate dust collection and proper ventilation.
7. Do not wear loose clothing or jewelry when operating this machine. Keep long hair tied back.
8. Always make sure the power switch is in the OFF position prior to plugging in the machine.
9. Always make sure the power switch is in the OFF position and the machine is unplugged when doing any cleaning, assembly, setup operation, or when not in use.
10. Make sure all safety guards and hardware are securely tightened before operating the machine.
11. Never start the jointer with the work piece on or near the cutterhead.
12. Check the depth of cut setting before turning the jointer on.
13. Never start the cut until the cutterhead reaches full speed.
14. Regularly check that the blades are locked tight in the cutterhead.
15. Always keep hands and fingers away from the cutterhead, chip exhaust opening, belts and pulleys to prevent injury.
16. Always use push blocks when jointing. Never place hands directly over the cutterhead.
17. Never joint wood less than 10" long, widths under 3/4", or material less than 1/2" thick.
18. Never make cuts deeper than 1/8". Multiple cuts, 1/16" or less, produce better finish results.
19. Make sure there are no loose knots, nails, staples, dirt or foreign objects in the work piece to be surfaced.
20. Use extra caution with large, warped, very small or awkward work pieces.
21. Use extra supports (roller stands, saw horses, tables etc, for any work pieces large enough to tip when not held down to the jointer's infeed and outfeed table surfaces.
22. Surface wood in the same direction of the grain, not across the grain. Never plane end cuts or end grain.
23. Joint only one work piece at a time. Vary the feeding of the work pieces along the cutterhead, center/left/right, so that all of the knives get used and thus remain sharp, longer.
24. Never back the workpiece towards the in-feed table.
25. Never reach inside of a running machine, and avoid awkward operations and hand positions where a sudden slip could cause fingers or a hand to move into the cutterhead.
26. Do not clear a jammed work piece while the machine is running. Stop the machine, unplug it from the power source, and then remove the jammed work piece.
27. Keep your face and body to one side of the machine during use, out of line with a possible 'kick back' (lumber caught in by the rotating cutterhead and thrown back towards the operator).
28. The use of any accessories or attachments not recommended may cause injury to you and damage your machine.
29. Sharpen or replace dull or chipped knives immediately, as injury to the user, or the machine, may result.
30. Replacement knives/inserts should be from, or through a source recommended by the manufacturer.
31. Remove material or debris from the work area. Keep work area neat and clean.



California Proposition 65 Warnings

WARNING: Drilling, sawing, sanding or machining wood products can expose you to wood dust, a substance known to the State of California to cause cancer. Avoid inhaling wood dust or use a dust mask or other safeguards for personal protection. For more information go to www.P65Warnings.ca.gov/wood

GETTING TO KNOW YOUR MACHINE

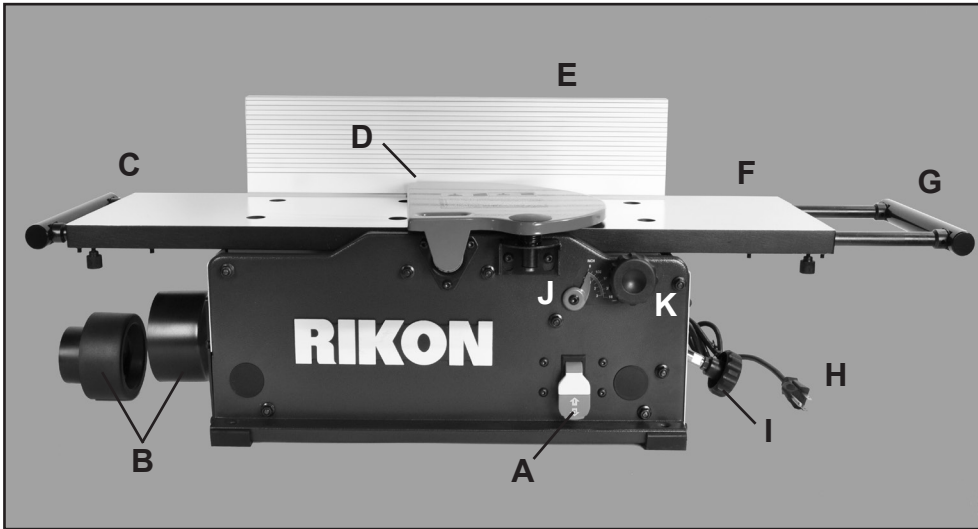

- A On / Off Safety Switch
- B Dust Port & Vacuum Adapter
- C Outfeed Table with Extension
- D Cutterhead Guard
- E Fence
- F Infeed Table
- G Infeed Table Extension
- H Power Cord
- I Depth of Cut Adjustment Knob
- J Depth of Cut Scale
- K Depth of Cut Lock Knob
- L Rubber Foot Pads
- M Drive Belt / Guard
- N Mounting Holes
- O Extension Table Lock Knob (4)
- P Fence Bracket Locking Handle
- Q Fence Support Locking Handle

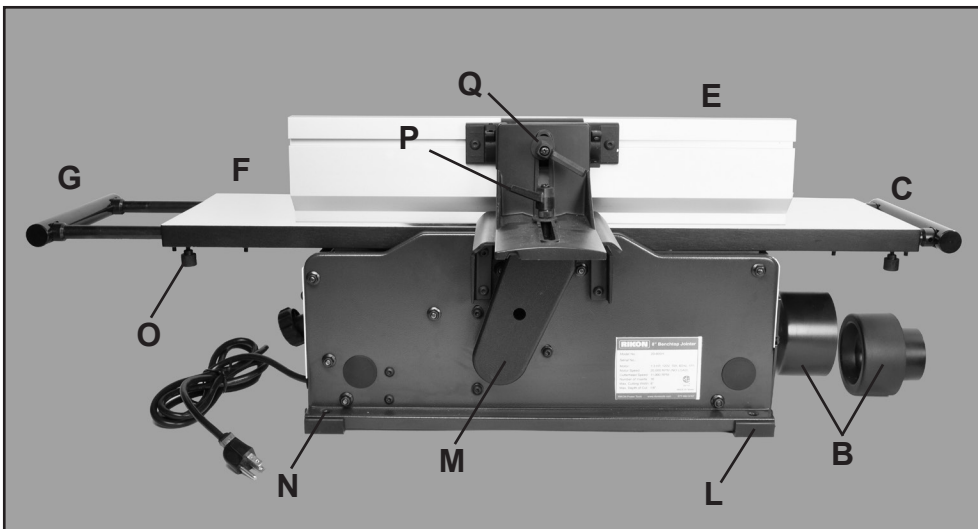

**SEE PAGES 20 thru 22
FOR THE
PARTS DIAGRAMS AND
PARTS LISTS**

CONTENTS OF PACKAGE

Model 20-800H Jointer is shipped complete in one box.

Unpacking and Clean-up

1. Carefully remove all contents from the shipping carton. Compare the contents with the list of contents to make sure that all of the items are accounted for, before discarding any packing material. Place parts on a protected surface for easy identification and assembly. If any parts are missing or broken, please call RIKON Customer Service (877-884-5167) as soon as possible for replacements. DO NOT turn your machine ON if any of these items are missing. You may cause injury to yourself or damage to the machine.
2. Report any shipping damage to your local distributor. Take photographs for any possible insurance claims.
3. Clean all rust protected surfaces with ordinary house hold type grease or spot remover. Do not use; gasoline, paint thinner, mineral spirits, etc. These may damage painted surfaces.
4. Apply a coat of paste wax to the tables to prevent rust. Wipe all parts thoroughly with a clean dry cloth. Be careful when working, as the jointer insert knives are sharp and may cause injury if touched.
5. Set packing material and shipping carton aside. Do not discard until the machine has been set up and is running properly.

CONTENTS OF PACKAGE

LIST OF LOOSE PARTS



- A. Jointer Assembly
- B. Fence Slide Bracket Assembly
- C. Fence
- D. Fence Bracket
- E. Vacuum Adapter 4" to 2-1/2" & 2-1/4"
- F. Push Blocks (2)
- G. Hex Wrenches - 2.5mm & 4mm
- H. T25 Screwdriver
- I. Lever Handle, Washer & Square Nut
- J. Fence Hex Head Bolt & Square Nuts (2)
- K. ON/Off Switch Safety Key Lock
- L. Manual (Not Shown)

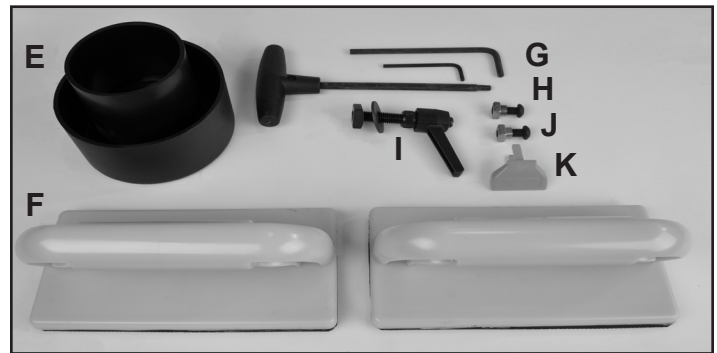
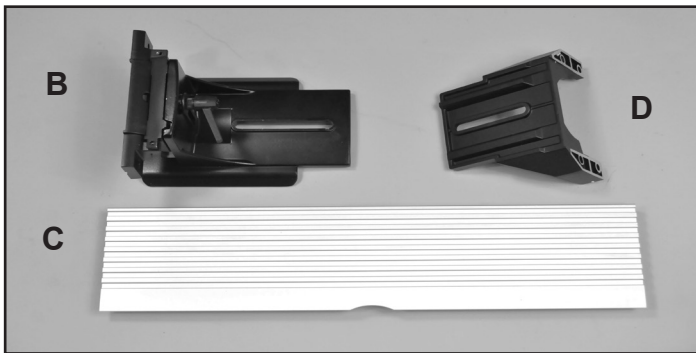

INSTALLATION

MOVING & INSTALLING THE JOINTER

CAUTION When moving the jointer, lift the unit by grasping the cabinet ends below the tables of the machine. Refrain from using the infeed and outfeed tables, as they are factory set and should not be disturbed. DO NOT carry or move the machine using the fence assembly, safety guard, dust chute or hand wheels.

1. The machine should be firmly bolted to a stand or workbench to avoid any movement of the machine during use. The jointer's base has holes in each of the four corners for this purpose (hardware is not included).

2. For portability and secure clamping of the jointer to a workbench, the machine can be first permanently bolted to a piece of plywood. Then the jointer can be positioned on your workbench, or other solid surface, and the plywood can be clamped in place to secure the jointer for use. After use, the plywood can be unclamped and the jointer stored for future use.

3. Position the machine on a solid, level bench that is located in an area that ample space in front and in back of the jointer for the moving of lumber to be milled. Align the machine so that during use, any kickback will not face aisles, doorways, or other work areas that bystanders may be in. Do not locate or use the machine in damp or wet conditions.



WARNING

THE MACHINE MUST NOT BE PLUGGED IN AND THE POWER SWITCH MUST BE IN THE 'OFF' POSITION UNTIL ASSEMBLY IS COMPLETE.

NOTE: The 20-800H Jointer requires minimal assembly, and therefore the machine can be mounted to a stand, workbench, or on a piece of plywood for portability and storage before assembling of the parts begins.

TOOLS REQUIRED FOR ASSEMBLY

Phillips Screwdriver

4mm, 10mm, 11mm or an Adjustable Wrench

ASSEMBLY



WARNING

THE MACHINE MUST NOT BE PLUGGED IN AND THE POWER SWITCH MUST BE IN THE 'OFF' POSITION UNTIL ASSEMBLY IS COMPLETE.

FENCE ASSEMBLY PROCEDURE

1. Assemble the Fence Bracket (A) to the jointer base (B). Use the four Socket Button Head Screws (C) to lock the bracket in place. FIG. 1.

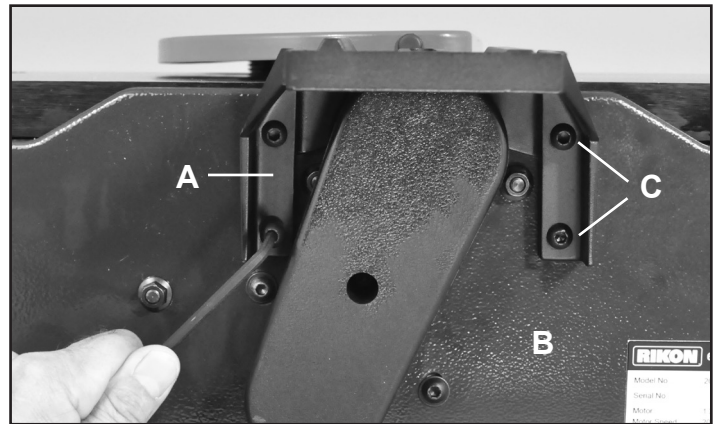

FIG. 1

2. Assemble the Fence Sliding Bracket (E) to the Fence (F). The Square Nut (G) should fit in the groove of the fence. FIG. 2.

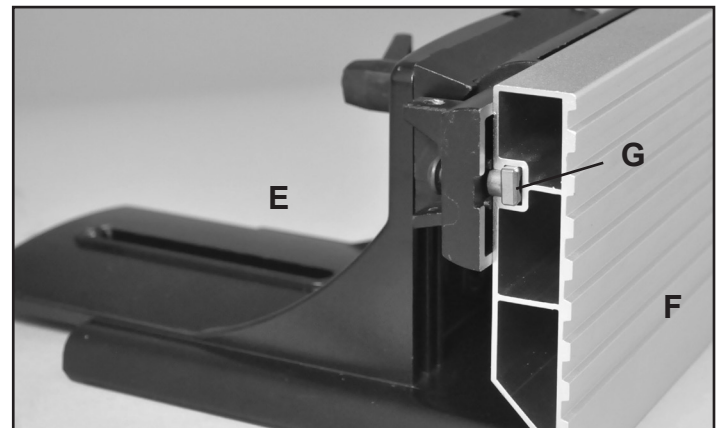

FIG. 2

3. Adjust the fence sliding bracket (E) to the middle of the fence at the center of the fence cut-out (H). Use two M6x16mm socket button head screws (I) to lock the sliding bracket in position. FIG. 3.

4. Locate the Sliding Bracket & Fence Assembly onto the mounting bracket on the body of the jointer. Insert the tilt lock Lever Assembly (J) with the flat washer (B) in place. FIG. 4.

CONTINUED ON PAGE 10

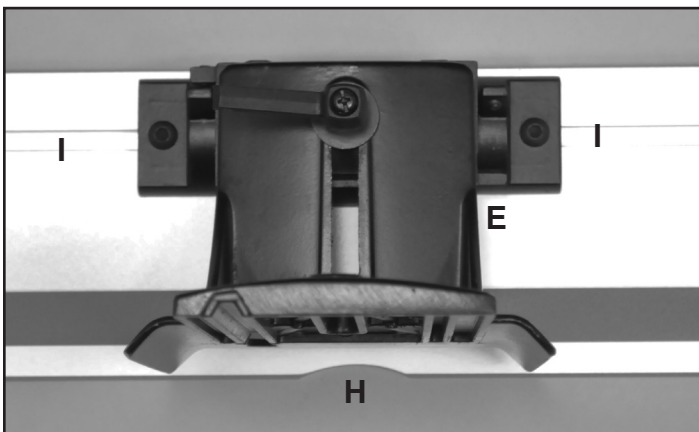

FIG. 3



FIG. 4

ASSEMBLY



WARNING

THE MACHINE MUST NOT BE PLUGGED IN AND THE POWER SWITCH MUST BE IN THE 'OFF' POSITION UNTIL ASSEMBLY IS COMPLETE.

CONTINUED FROM PAGE 9

5. With the tilt lock lever assembly in place on the positioned fence sliding bracket and fence bracket, put the special rectangular shaped Nut (A) onto the lever handle's threaded shaft. Turn the lever to engage the nut and lock both brackets together into position. FIG. 5.

6. Use an Angle Gauge to measure the 90° & 135° angles between the Fence and Jointer Table Top. Adjusting can be done by loosening / tightening the Nylock Hex Socket Head Screws (B). FIG. 6 & 7.

See page 14 for more information on Fence Adjustments.

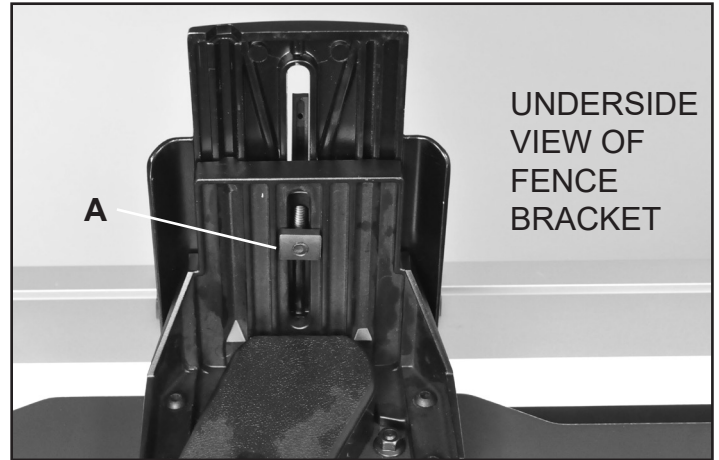

FIG. 5

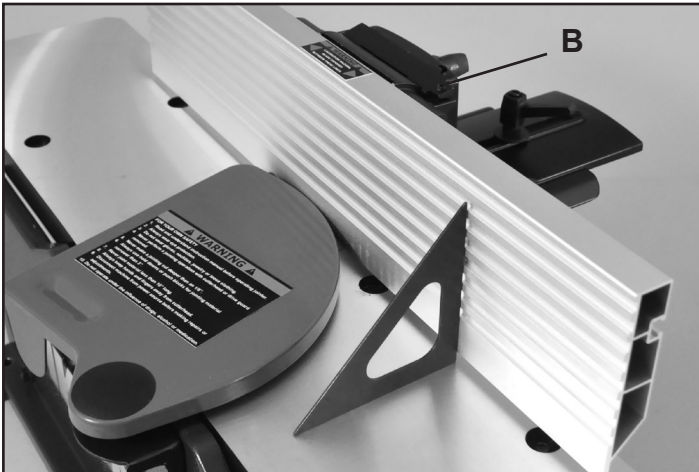

FIG. 6

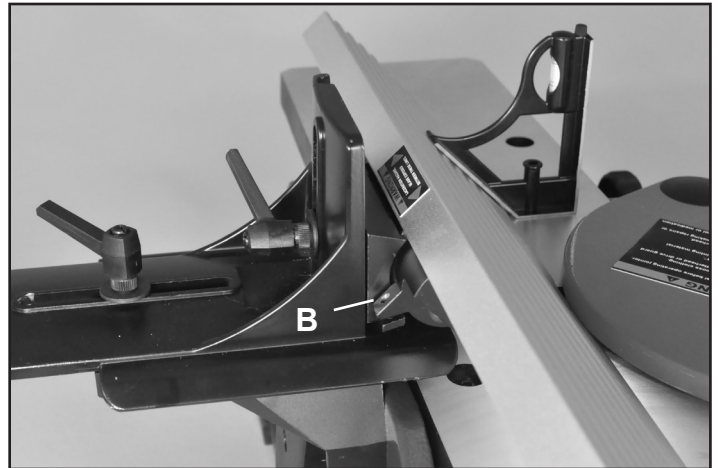

FIG. 7

CUTTERHEAD GUARD ASSEMBLY

NOTE: Pending factory settings, the cutterhead guard may already be pre-installed on the jointer. If so, disregard this step. If the guard is not installed, follow the installation step below.

1. Attach the Cutterhead Guard to the jointer with the two Button Head Screws (A). FIG. 8.

The cutterhead guard has a tension return spring. The tension on this spring is set at the factory. When the guard is installed properly, it should return to the fence automatically after the workpiece has passed over the cutterhead. Be sure the guard is functioning properly every time before using the jointer.

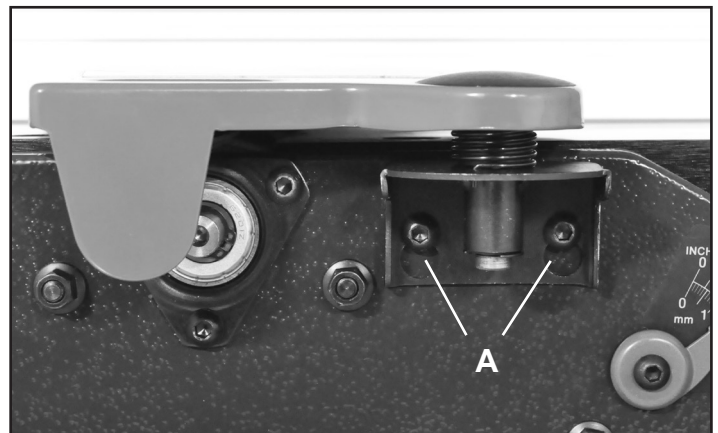

FIG. 8

ASSEMBLY

DUST PORT

A Dust Port is supplied with the jointer to help connect it to a standard 4 inch or 2-1/2 inch vacuum hose.

The main Dust Port (A) is pre-assembled at the factory with a 4 inch OD fitting. In addition a Vacuum Adapter (B) is provided to reduce to 2-1/2 inch (OD) or 2-1/4 inch (ID) hose sizes. FIG. 9.

NOTE: It is extremely important that a dust collection system is used with this jointer to eliminate harmful airborne dust, prevent the build-up of chips that may jam the cutterhead, and to keep the working area clean of debris. Make sure all connections are secure and your dust collector is turned on before any milling of lumber is done.

However, if you do not plan to use a dust collector, then there is no need to attach this dust port to the jointer. Chips ejected from the operating machine should be collected and disposed of immediately to keep the area clean and to avoid accidents.

TABLE ADJUSTMENT KNOB ASSEMBLY

Attach the infeed table's Adjustment Knob (A) to the jointer by tightening the hex nut (B) with a 10 mm and 13mm open end wrenches. FIG. 10.

SWITCH

The jointer is turned on by flipping the switch into the up position, and it is turned off by flipping the switch in the down position.

This jointer is also equipped with a special lockout toggle switch that prevents unauthorized use. To prevent unauthorized use of the jointer, simply pull out the yellow key (A) located on the face of the switch. FIG. 11.

CAUTION: DO NOT continuously use the jointer at the maximum depth of cut, 1/8 in. (3mm), as it will put excessive stress on the motor which will damage it.

⚠ WARNING THE MACHINE MUST NOT BE PLUGGED IN AND THE POWER SWITCH MUST BE IN THE OFF POSITION UNTIL ALL ADJUSTMENTS ARE COMPLETE.

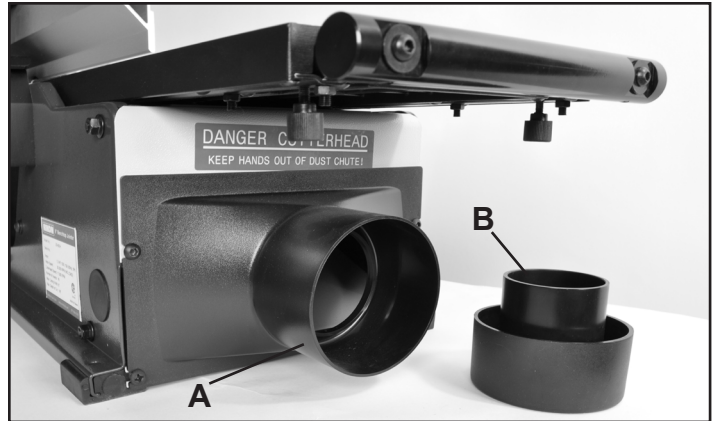

FIG. 9

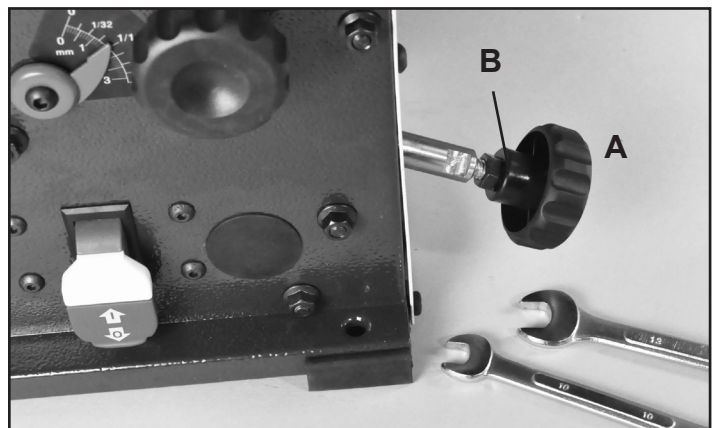

FIG. 10

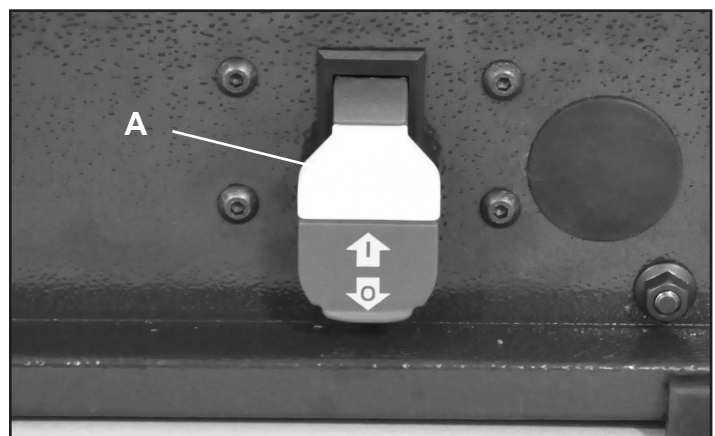

FIG. 11

⚠ WARNING Before turning on the machine, review the safety precautions listed on pages 3 to 6. Make sure that you fully understand the features, adjustments and capabilities of the machine that are outlined throughout this manual.

OPERATION

NOTICE: This operations section was designed to give instructions on the basic operations of this jointer. However, it is in no way comprehensive of every jointer operation. It is strongly recommended that you read books, trade magazines, or get formal training to maximize the potential of your jointer while minimizing the risks. **NOTICE:** This jointer is designed to surface natural wood ONLY.

WARNING Before turning on the machine, review the safety precautions listed on pages 3 to 6. Make sure that you fully understand the features, adjustments and capabilities of the machine that are outlined throughout this manual.

STARTING AND STOPPING JOINTER

1. The ON/OFF switch (A) is located on the front of the jointer. To turn the jointer "ON", the yellow Safety Tab (A) must be inserted in the switch. Then move the switch upwards to start the machine.
2. To turn the jointer "OFF", move the switch downwards. FIG 12.

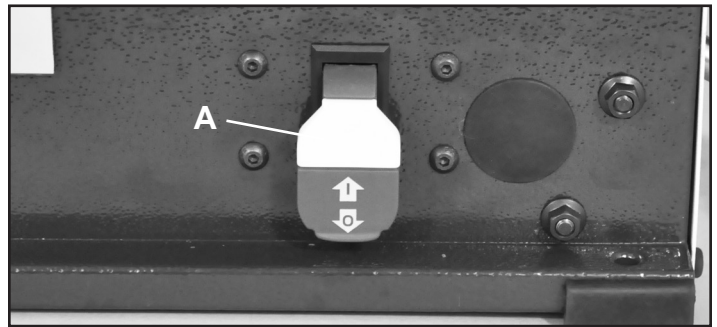

FIG. 12

DIRECTION OF GRAIN

Feed the wood into the jointer with the grain to obtain a smooth surface. FIG 13.

Avoid feeding work into the jointer against the grain. The result will be chipped and splintered edges on the wood surface.

CAUTION: DO NOT continuously use the jointer at the maximum depth of cut, 1/8 in. (3mm), as it will put excessive stress on the motor which will damage it.

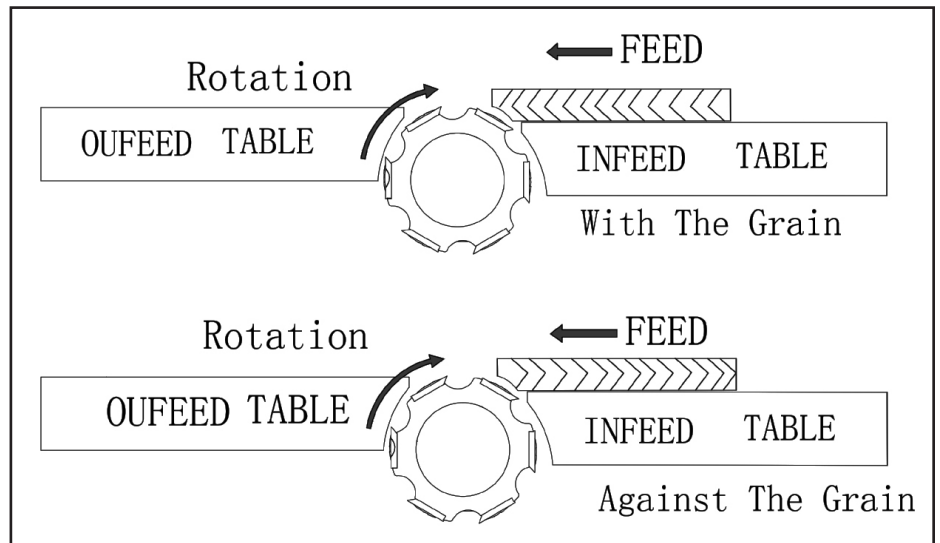

FIG. 13

JOINTER OPERATION

The function of the jointer is to surface plane flat, one side or edge of a board/workpiece.

To use the jointer:

1. Connect your Dust Collector Hose to the Dust Port.

It is extremely important that a dust collection system is used with this jointer to eliminate harmful airborne dust, prevent the build-up of chips that may jam the cutterhead, and to keep the working area clean of debris.

NOTE: Workpiece dimensions for jointing:

- Length: use a push block or stick to feed boards shorter than 12"; use support rollers for long boards for safe control and accurate planing.
- Width: maximum 6".
- Thickness: minimum 1/2". The use of push blocks is necessary when face planing thin material.
- Depth of Cut: maximum 1/8". Multiple cuts of 1/16" or less, produce better finish results.

OPERATION

FEEDING THE WORKPIECE

Place the workpiece on top of the right, infeed table. The workpiece will be cut on its underside by the rotating cutterhead knives. When jointing, the feeding direction of the workpiece is right-to-left over the cutterhead. FIG. 14.

1. Assume the proper operating position: stand to the side of the infeed table with feet apart for stability through the whole cutting process. FIG. 14.
2. Set the jointer fence position and angle as required.
3. Set the depth of cut / thickness (See below).
4. Place the workpiece against the jointer fence for support through the cutting action. FIG. 15.
5. Make sure that the cutterhead guard is against the workpiece for user protection.

NOTE: For jointing the edge of a board, set the workpiece against the fence. The spring action blade guard should be touching the workpiece, covering the cutterhead knives. Push the workpiece slowly and steady over the cutterhead. Ensure that the fence is set at true 90° (or any other angle required (see pages 10 & 14) and the workpiece is kept flush against the fence.

For planing the face of a board or workpiece, follow the same procedure as above.

6. Turn the machine on and place the workpiece on the infeed table. Feed the workpiece toward the cutterhead, FIG. 16, exerting downward pressure until the workpiece clears the cutterhead on the outfeed table side. Always keep your hands away from the cutterhead to avoid any accidents.

NOTE: The use of push blocks is recommended.

Run boards at different positions along the width of the cutterhead to utilize the full length of the cutting knives. Jointing in one area of the cutterhead, will quickly dull the knives in that area.

SETTING DEPTH OF CUT

The jointer can be set to cut any depth from a very thin shaving to 1/8" deep. The pointer (A) on the scale (B) is to indicate the depth of cut. To adjust the depth of cut, loosen lock knob (C) and turn adjusting knob (D) clockwise to lower and counterclockwise to raise the infeed table until the infeed table is at the desired position, then tighten the lock knob (C). FIG. 17.

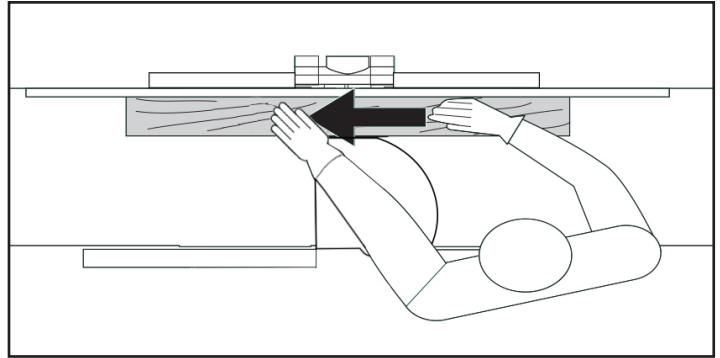

FIG. 14



FIG. 15

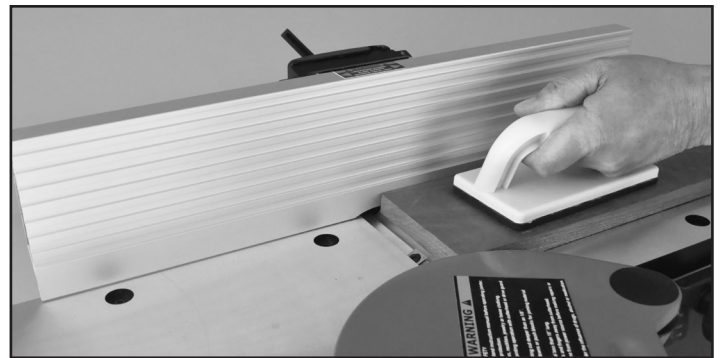

FIG. 16

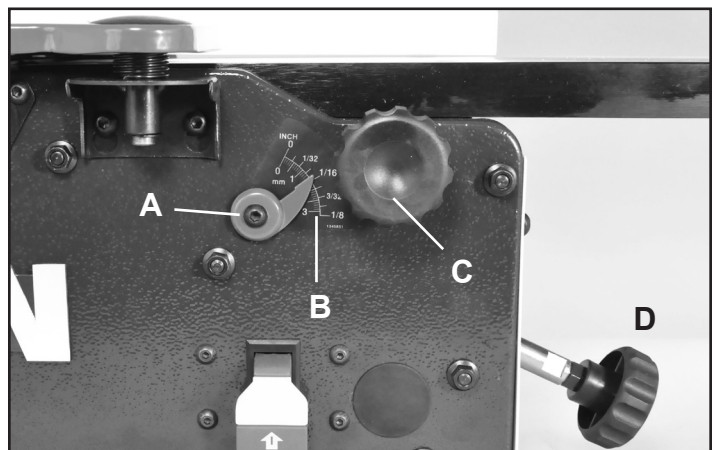

FIG. 17

ADJUSTMENTS

⚠ WARNING THE MACHINE MUST NOT BE PLUGGED IN AND THE POWER SWITCH MUST BE IN THE OFF POSITION UNTIL ALL ADJUSTMENTS ARE COMPLETE.

FENCE ADJUSTMENTS

1. To move the fence across the table, loosen the lock lever (A), slide the fence to the desired position on the table and then retighten the lock lever. FIG. 18.

NOTE: The handle direction of the lock levers (A) and (B) can be repositioned by pulling up the lever and repositioning it on the nut located underneath the lever.

2. To tilt the fence, loosen the lock lever (B), and tilt the fence to the desired angle. Then retighten the lock lever. FIG. 18.

3. The fence has adjustable positive stops at the most used fence positions of 90 degrees and 135 degrees.

SETTING THE FENCE TO 90° and 135°

To check and adjust the positive stops to the 90 and 135 degree settings:

4. Put a square on the table with one end against the fence and adjust the fence until it is exactly 90 degrees to the table. FIG. 19.

5. Tighten the set screw (C) with a hex wrench until it contacts the stop. FIG. 20.

6. Put a square on the table with one end against the fence and adjust the fence until it is exactly 135 degrees to the table. FIG. 21.

NOTE: With the fence set at 135°, the jointer will produce a 45° bevel on your workpiece.

7. Tighten set screw (D) with a hex wrench until it contacts the stop. FIG. 20.

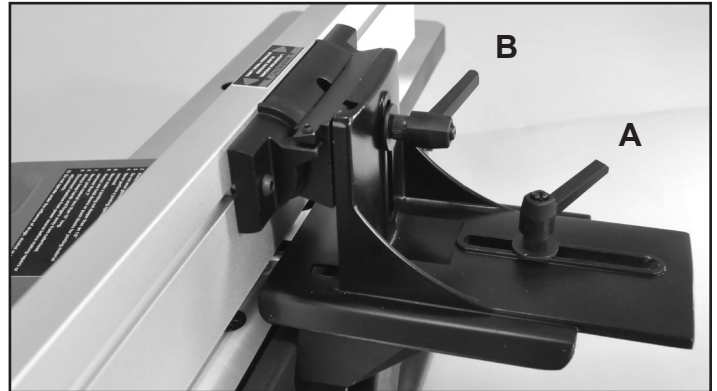

FIG. 18

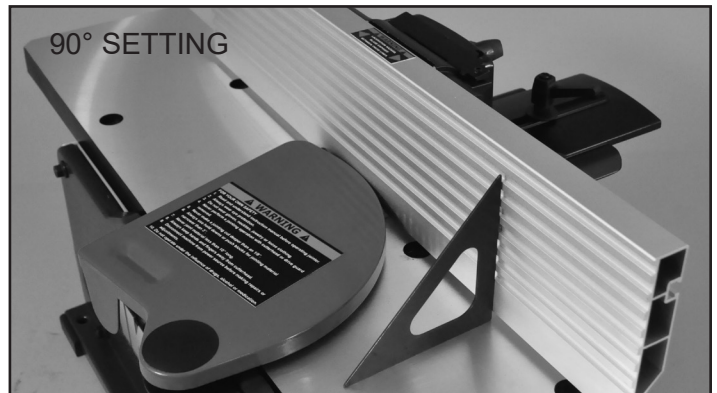

FIG. 19

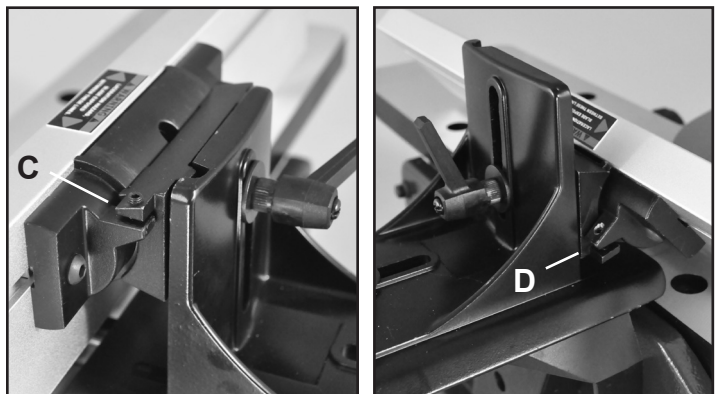

FIG. 20

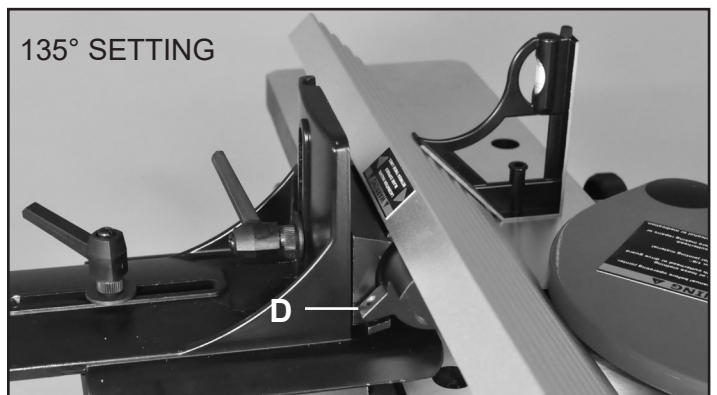

FIG. 21

ADJUSTMENTS

ROTATING OR REPLACING KNIFE INSERTS

This machine has a helical-style cutterhead with six rows of Carbide knife inserts. Each of the 16 inserts on the cutterhead are indexed and have two sharpened sides. If the knives become dull, or one becomes nicked, simply loosen the retaining screws with the supplied star head screwdriver, lift up and rotate the inserts to a new sharpened edge. No setting is required, as the cutterhead has been machined to automatically index and set the inserts in proper position for use. When both edges of an insert are dull, the insert can be easily removed and a new carbide insert placed in the location. To rotate or remove an insert:

1. Unplug power cable and make sure that the switch is in the off position, with the safety tab removed.
2. To keep the cutterhead from rotating while working on the knives, insert the supplied hex wrench into the end of the cutterhead shaft that faces the front of the machine, under the guard's front tab. The cutterhead can then be safely rotated and positioned for changing the insert cutters. FIG. 22.

3. Remove the Star Screw, that holds the Insert in the cutterhead, and also remove the Insert Knife. FIG. 23.

CAUTION Wear gloves when changing knife inserts to avoid the risk of personal injury by cuts that may result from touching the sharp edges!

4. While the insert is removed, clean any resin build-up or trapped dust from the surfaces of the cutterhead with a suitable solvent. A tooth brush works well for safe cleaning around the sharp inserts. Any accumulated dust can affect the seating of the insert in

WARNING THE MACHINE MUST NOT BE PLUGGED IN AND THE POWER SWITCH MUST BE IN THE OFF POSITION UNTIL ALL ADJUSTMENTS ARE COMPLETE.

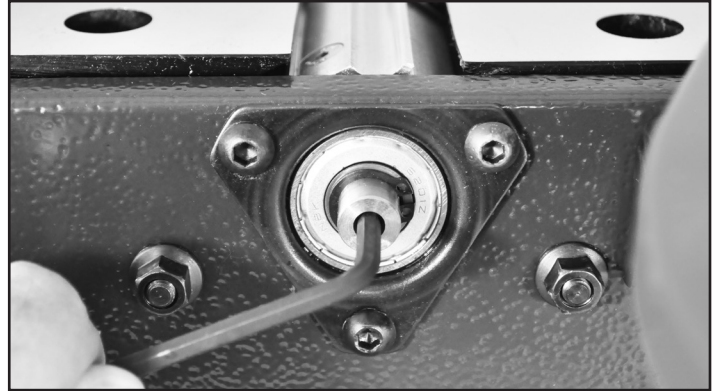

FIG. 22

the cutterhead, causing it to rise slightly and make a small, but noticeable mark on your workpiece next time you mill stock. NOTE; these marks/lines will easily sand off in your finishing process.

5. Rotate the insert so that a new sharpened edge is in position. The inserts have a indication mark on their top surface corner, so that you can reference the positioning of the insert's dulled or sharpened edges. FIG. 23.

5. Tighten the insert's set screw to lock the insert back in position. DO NOT overtighten the screw or damage to the insert may result. Torque the screw in place to 48-50 in/lbs.

6. Plug in the power cable and return the safety tab into the switch when you are ready to resume jointing on the machine.

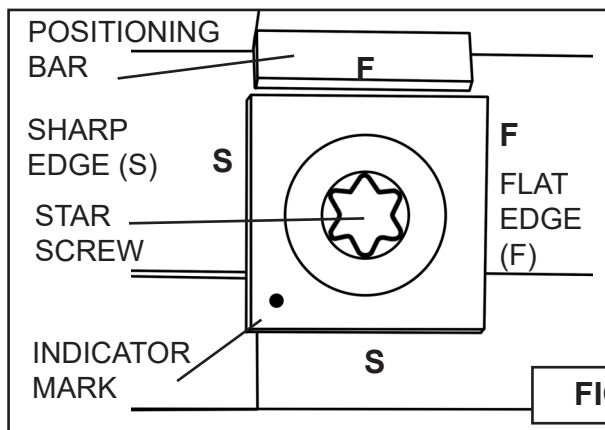
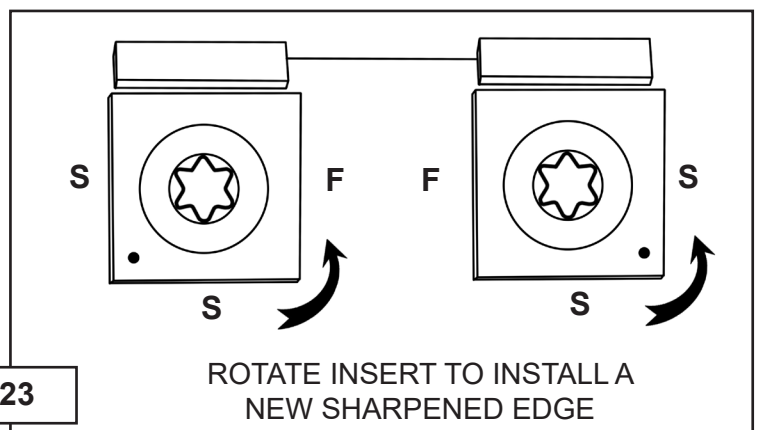

FIG. 23



ADJUSTMENTS

TABLE ADJUSTMENTS

The infeed and outfeed tables are preset at the factory to be aligned with the cutterhead. To ensure that both tables are aligned, check both table settings and adjust as necessary.

CAUTION This procedure involves close contact with the jointer blades. Wear gloves to prevent injury to the hands. Make sure that the machine is disconnected from the power supply.

1. Set the infeed table to the '0' setting on its depth of cut scale.
2. Rotate the cutterhead so that the knife inserts are at their highest point.

To rotate the cutterhead and keep it from moving while working on the tables, use the supplied hex wrench and insert it into the end of the cutterhead shaft that faces the front of the machine, under the guard's front tab. The cutterhead can then be safely rotated and positioned. See FIG. 22 on page 15.

3. With a long metal straight edge, place it lengthwise along the outfeed table so that it extends onto the insert cutter at its highest rotation point. Check the measurement on the insert cutter to the far right and then far left on the cutterhead. FIG. 24.

4. If the straight edge does not touch the insert cutter(s), the outfeed table will need to be adjusted.

A. Use a hex wrench to loosen and remove the hex bolt on that is countersunk on the table surface. This will reveal a washer and slotted, table height adjustment screw under the hex bolt. FIG. 25.

B. Use a slotted screwdriver to adjust the outfeed table until it is parallel with the edge of the cutter(s). FIG. 26.

NOTE: The adjustment should be less than 1/20th turn each time. Turning clockwise will lift up the table, turning counterclockwise will lower the table.

C. Once the table is set, return the washer and reinstall the hex bolt back to secure the table in its new setting.

WARNING THE MACHINE MUST NOT BE PLUGGED IN AND THE POWER SWITCH MUST BE IN THE OFF POSITION UNTIL ALL ADJUSTMENTS ARE COMPLETE.

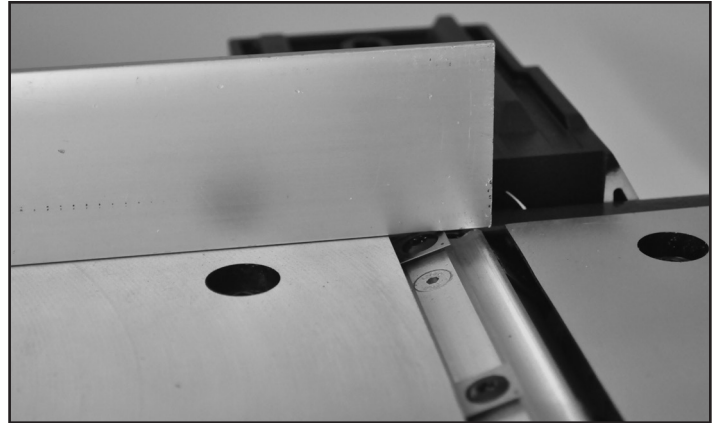

FIG. 24

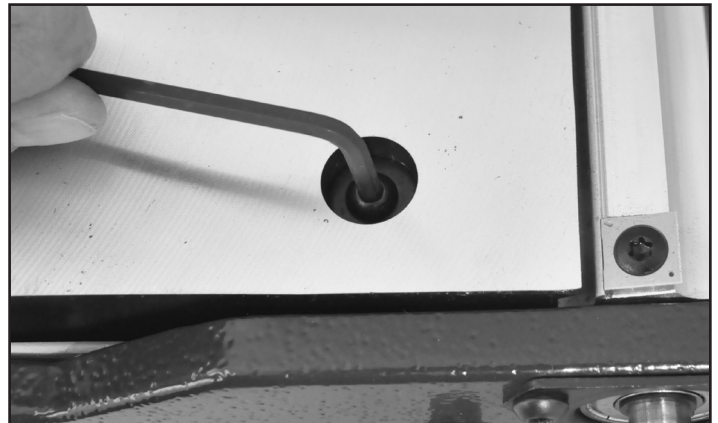

FIG. 25



FIG. 26

CONTINUED ON PAGE 17

ADJUSTMENTS

CONTINUED FROM PAGE 16

5. Do the same measurement with the straight edge from the infeed table, to the same insert cutters that were used to measure the outfeed table.

6. Once the infeed and outfeed tables are aligned with the cutterhead cutters, the tables need to be checked to confirm that their surfaces are parallel with each other - ends not tilting or angling down or up from the cutterhead.

5. Lie the straight edge across BOTH tables. FIG. 27. They should be set at the same height and perfectly level to each other.

- If it does, the tables are true to each other.
- If the straight edge does not lie flat across both tables, then the tables must be adjusted. Tune the outfeed table to the infeed table.

6. Adjust the angle and tilt of the outfeed table with the slotted screws as described in steps 4 A-C.

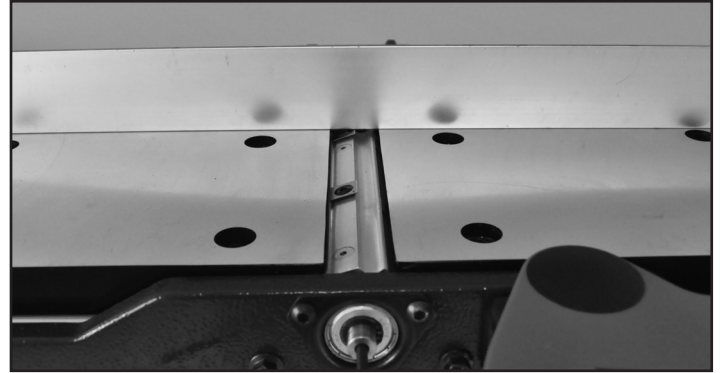

FIG. 27



FIG. 28

INFEED / OUTFEED EXTENSION SUPPORTS

The overall table length can be expanded from 30-1/2" to 51-1/2". This can be done by loosening the four extension table lock knobs (A-Fig 28). Extend the supports to the desired lengths and tighten the four extension table lock knobs.

The infeed and outfeed extension supports are adjustable to be level with the main table if ever necessary. These are set at the factory. If after planing or edge joining a work piece and adjustment is necessary, follow these instructions:

1. Place a straight edge on the outfeed table across the outfeed extension support and check for level.
2. The straight edge should lay flat on the outfeed table and the outfeed extension support. The straight edge should just touch or leave a small gap from the outfeed extension support. Figure 29.
3. If level adjustment is needed, loosen the extension table lock knobs (A-Fig 28).
4. Loosen the locking set screw on the bottom-side of the extension support. Figure 30.

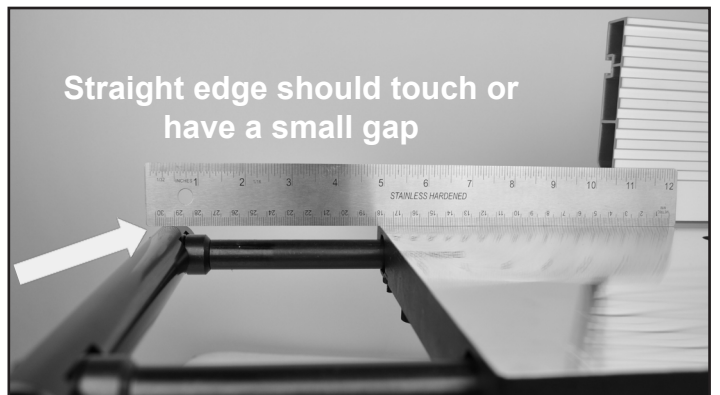

FIG. 29



FIG. 30

ADJUSTMENTS

CONTINUED FROM PAGE 17

5. Rotate extension leveling cam (A-Fig.31) by placing a Hex Key in the adjustment hole (B-Fig.31).
6. Once the desired height is achieved tighten the locking set screw (Fig.30 Page17).
7. Repeat steps 1 through 5 for leveling the infeed table extension support.

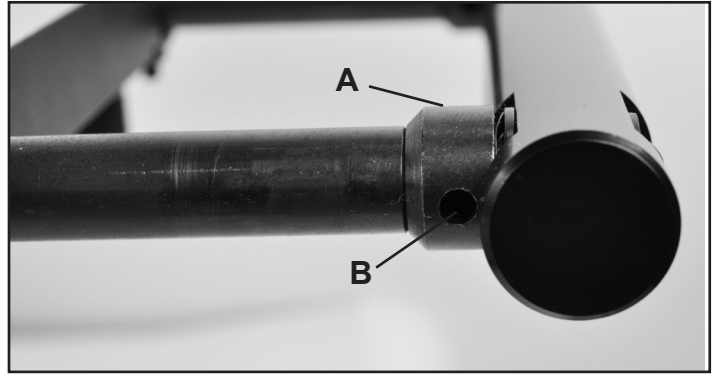

FIG. 31

REPLACING THE DRIVE BELT

1. Use the supplied 4MM Hex Key to loosen the screw of the belt guard and then remove the guard from the rear of the jointer. FIG. 32.
2. Remove the old belt. If the belt is stretched and loose enough, flex the belt outward while rotating the upper pulley clockwise to roll the belt off the pulleys. If the belt is tight and can not be moved off of the pulley, the belt tension can be released to permit the removal of the old belt and mounting of the new belt on the pulleys.



FIG. 32

- Loosen the 3 screws (FIG. 33, A), and push the lower motor pulley (B) upward.
- Remove the old belt, and install the new belt onto the two pulleys.
- Press down on the lower motor pulley to put tension back onto the belt, and tighten the 3 screws.

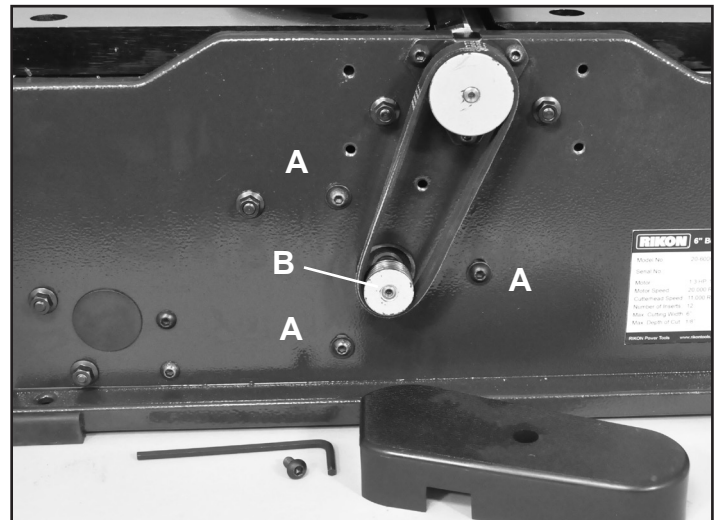
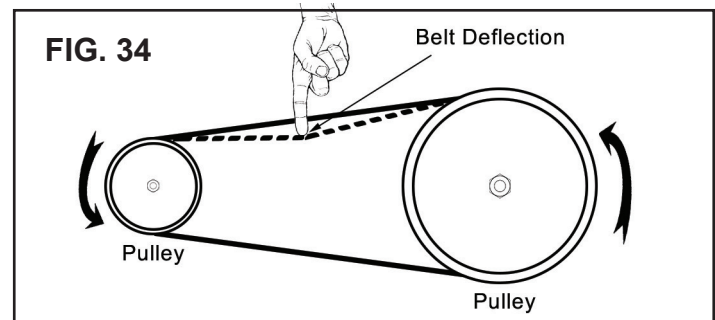

FIG. 33

NOTE: Check the tension with thumb pressure. The drive belt should not give more than 1/4" in the center. FIG. 34.

3. Replace the blade guard over the drive belt and secure it in place with the screw from step 1.



MAINTENANCE

⚠ WARNING: Turn the power switch “OFF” and disconnect the plug from the outlet prior to adjusting or maintaining the machine. DO NOT attempt to repair or maintain the electrical components of the motor. Contact a qualified service technician for this type of maintenance.

1. Before each use:
 - Check the power cord and plug for any wear or damage.
 - Check for any loose screws or hardware.
 - Check the area to make sure it is clear of any misplaced tools, lumber, cleaning supplies, etc. that could hamper the safe operation of the jointer.
2. To avoid a build-up of wood dust, regularly clean all parts of the machine using a soft cloth, brush or compressed air. A general cleaning should be done after every use to avoid future problems and ensure the machine is in ready condition for the next time it is used.

WARNING: If blowing sawdust, wear proper eye protection to prevent debris from blowing into eyes. Air pressure above 50 PSI should not be used as high-pressured air may damage insulation, etc.

3. Check the knives to make sure that they are not loose from the cutterhead, dull or nicked. Making sure that they are in proper operating condition will ensure that the quality of your surfaced lumber will be the best possible.

4. Lubricate all bearing points regularly with a few drops of light motor oil. Cutterhead ball bearings are lifetime lubricated, sealed, and do not need any further care. Keep the drive belt free of oil and grease.

5. Keep the jointer tables free of resin and rust. Clean them regularly with a non-flammable solvent, then coat with a light film of dry lubricant spray, or wax, to enhance passage of work piece on/over the tables. Never use solvents to clean plastic parts, as they could dissolve or damage the material.

WARNING: When cleaning or working on the tables, avoid the risk of personal injury by cuts that may result from touching the knife inserts' sharp edges!

6. Check the drive belt tension after the first 3-5 hrs. of operation to ensure that the belts have not become stretched and loose from their 'breaking in' use. See page 18 for instructions.

Service beyond recommended maintenance on these tools should only be performed by an authorized, qualified technician.

WIRING DIAGRAM

⚠ WARNING: This machine must be grounded. Replacement of the power supply cable should only be done by a qualified electrician. See page 5 for additional electrical information.

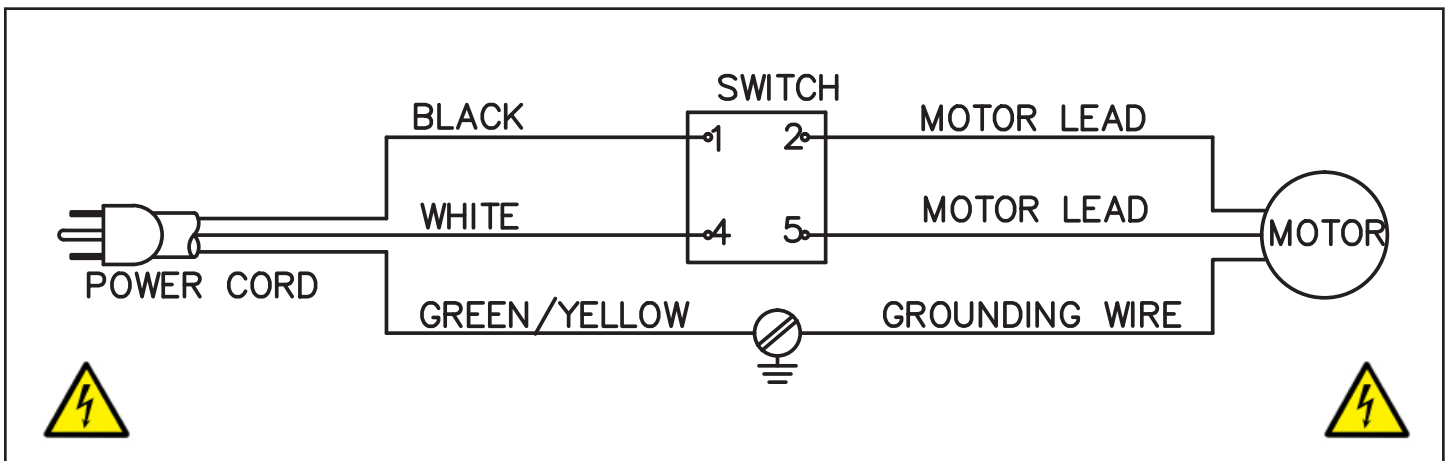

This tool is intended for use on a circuit that has a 120 volt electrical receptacle. The illustration on page 5 shows the type of 120V, 3-wire electrical plug and receptacle that has a grounding conductor that is required.

PARTS DIAGRAM

20-800H 8" JOINTER

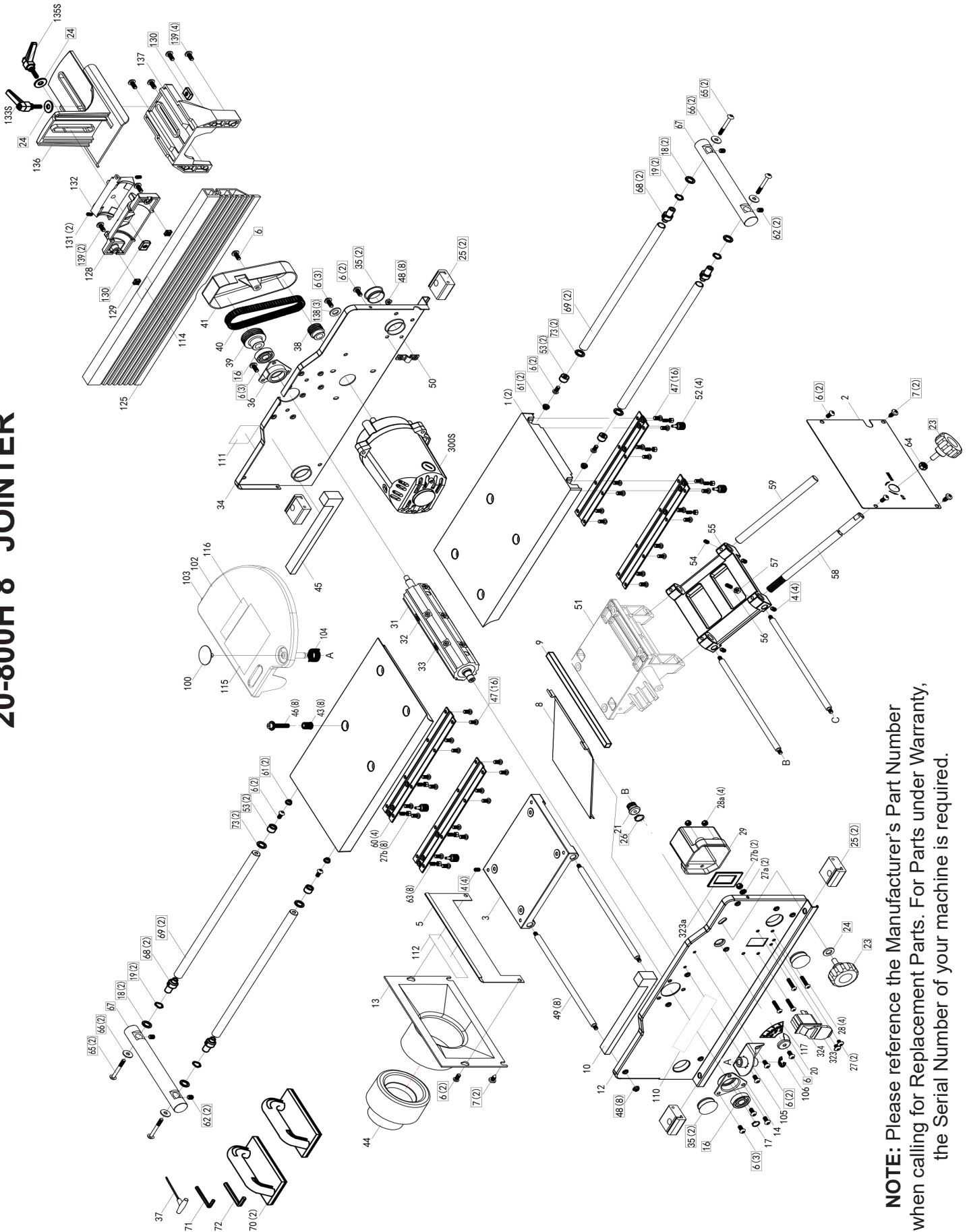

NOTE: Please reference the Manufacturer's Part Number when calling for Replacement Parts. For Parts under Warranty, the Serial Number of your machine is required.

PARTS LIST

KEY NO.	DESCRIPTION	QTY.	PART NO.	KEY NO.	DESCRIPTION	QTY.	PART NO.
1	TABLE	2	P20-800H-1	49	TIE ROD	8	P20-800H-49
2	RIGHT COVER	1	P20-800H-2	50	CORD CLAMP	1	P20-600H-50
3	OUTFEED SUPPORT	1	P20-800H-3	51	INFEED SUPPORT	1	P20-800H-51
4	SET SCREW M6x8L	8	P20-600H-4	52	LOCK KNOB	4	P20-800H-52
5	END COVER	1	P20-800H-5	53	FLAT WASHER M6.2x161x2T	4	P20-800H-53
6	BUTTON HD SCREW M6x12L	20	P20-600H-6	54	SET SCREW M6x10	1	P20-600H-54
7	SELF TAP SCREW 1/4"x 5/8"	4	P20-800H-7	55	BRACKET	1	P20-800H-55
8	DUST CHUTE	1	P20-800H-8	56	SET SCREW M6x16	1	P20-600H-56
9	FOAM SEAL 1	1	P20-800H-9	57	HEX NUT M6xP1.0	1	P20-600H-57
10	FOAM SEAL 2	1	P20-800H-10	58	ADJUSTING ROD	1	P20-600H-58
11	KNOB SHAFT	1	P20-800H-11	59	SHAFT	1	P20-600H-59
12	FRONT FRAME	1	P20-600H-12	60	PLATE	4	P20-800H-60
13	DUST PORT	1	P20-800H-13	61	BUMPER	4	P20-800H-61
14	BEARING RETAINER	1	P20-600H-14	62	HEX NUT M5xP0.8	8	P20-800H-62
15	BRACKET	1	P20-800H-15	63	SCREW M5xP0.8x12L	8	P20-800H-63
16	BEARING 6201ZZ	2	P20-600H-16	64	HEX NUT M8xP1.25x13L	1	P20-800H-64
17	EXT RETAINING RING STW12	1	P20-600H-17	65	SCREW M6xP1.0x50L	4	P20-800H-65
20	POINTER	1	P20-600H-20	66	FLAT WASHER M6.4XP1.0	4	P20-800H-66
21	GEAR	1	P20-600H-21	67	EXTENSION HANDLE	2	P20-800H-67
22	SPACING SLEEVE	1	P20-800H-22	68	EXTENSION LEVELING CAM	4	P20-800H-68
23	TABLE KNOB M8xP1.25x18L	2	P20-600H-23	69	EXTENSION SLIDING POST	4	P20-800H-69
24	FLAT WASHER M8x23x2T	3	P20-600H-24	70	PUSH BLOCK	2	P20-600H-70
25	RUBBER FOOT	4	P20-600H-25	71	HEX WRENCH 2.5MM	1	P20-600H-71
26	EXT RETAINING RING STW16	2	P20-600H-26	72	HEX WRENCH 4MM	1	P20-600H-72
27	PHILLIPS SCREW M5xP0.8x8L	2	P20-600H-27	100	HOLE PLUG	1	P20-600H-100
27a	LOCK WASHER EXT M5	2	P20-600H-27A	102	CUTTERHEAD GUARD	1	P20-800H-102
27b	HEX NUT M5	10	P20-600H-27B	103	BUMPER	1	P20-600H-103
28	HEX SCREW M5xP0.8x25L	4	P20-600H-28	104	SPRING	1	P20-600H-104
28a	LOCK NUT M5	4	P20-600H-28A	105	BRACKET	1	P20-600H-105
29	SWITCH BOX	1	P20-600H-29	106	EXT RETAINING RING	1	P20-600H-106
31	SPIRAL CUTTERHEAD	1	P20-800H-31	110	FLAT WASHER 5.4x14x2.0T	1	P20-600H-110
32	INSERT	16	25-499C (PK10)	111	SPEC LABEL	1	P20-800H-111
33	TORX SOCKET HEAD CAP	16	P20-600H-163	112	WARNING LABEL	1	P20-600H-8
34	REAR FRAME	1	P20-600H-34	115	WARNING LABEL	1	P20-600H-102
35	HOLE PLUG	4	P20-600H-35	116	INSERT REPLACEMENT LABEL	1	P20-800H-116
36	BEARING RETAINER	1	P20-600H-36	117	SCALE	1	P20-600H-22
37	TORX WRENCH T25	1	P20-600H-166	125	FENCE	1	P20-600H-125
38	DRIVE PULLEY	1	P20-600H-38	128	BEVEL BRACKET	1	P20-600H-128
39	CUTTERHEAD PULLEY	1	P20-600H-39	129	SQUARE NUT	2	P20-600H-129
40	BELT	1	P20-600H-40	130	SPECIAL NUT	2	P20-600H-130
41	BELT GUARD	1	P20-600H-41	131	NYLOK SOC HD SCREW	2	P20-600H-131
42	POINTER SHAFT	1	P20-800H-42	132	INTERMEDIATE BRACKET	1	P20-600H-132
43	ADJUST SCREW	8	P20-600H-43A	133S	TILT LOCK LEVER ASSY	1	P20-600H-133S
44	VACUUM ADAPTOR	1	P20-800H-44	135S	TILT LOCK LEVER ASSY	1	P20-600H-135S
45	FOAM SEAL 3	1	P20-800H-45	136	FENCE SLIDE BRACKET	1	P20-600H-136
46	SCREW M6xP1.0	8	P20-600H-46	137	FENCE BRACKET	1	P20-600H-137
47	BUTTON HD SCR 5xP.08	32	P20-800H-47	138	FLAT WASHER M6X12.5	3	P20-800H-138
48	FLANGE NUT M6xP1.0	16	P20-600H-48	139	SOC BUTTON HD SCREW	9	P20-600H-139

PARTS CONTINUED

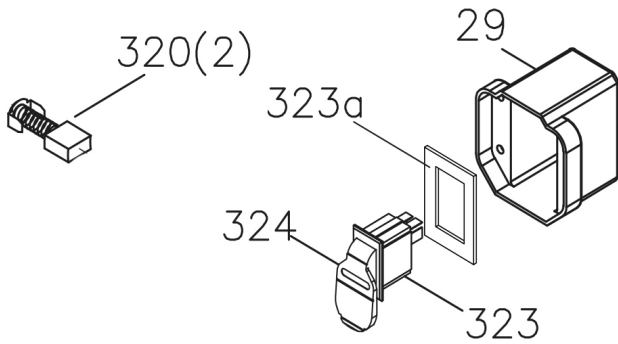
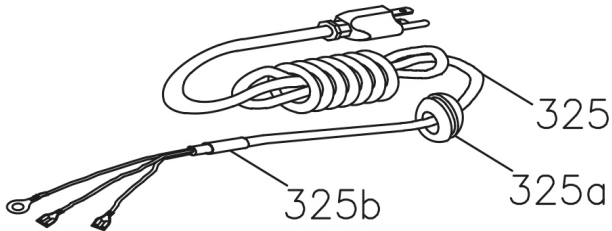

KEY NO.	DESCRIPTION	QTY.	PART NO.
29	SWITCH BOX	1	P20-600H-29
320	BRUSH	2	P20-600H-320
323	ON/OFF SWITCH	1	P20-600H-323
323a	SWITCH COVER	1	P20-600H-323-1
324	SWITCH KEY	1	P20-600H-324
325	POWER CORD	1	P20-600H-325
325a	GROMMET	1	P20-600H-325-1
325b	SLEEVE 12x22Lx0.8T	1	P20-600H-325-2

WARRANTY

RIKON
POWER TOOLS®

5-Year Limited Warranty

RIKON Power Tools Inc. ("Seller") warrants to only the original retail consumer/purchaser of our products that each product be free from defects in materials and workmanship for a period of five (5) years from the date the product was purchased at retail. This warranty may not be transferred.

This warranty does not apply to defects due directly or indirectly to misuse, abuse, negligence, accidents, repairs, alterations, lack of maintenance or normal wear and tear. Under no circumstances will Seller be liable for incidental or consequential damages resulting from defective products. All other warranties, expressed or implied, whether of merchantability, fitness for purpose, or otherwise are expressly disclaimed by Seller. This five-year warranty does not cover products used for commercial, industrial or educational purposes. The warranty term for these claims will be limited to a two-year period.

This limited warranty does not apply to accessory items such as blades, drill bits, sanding discs, grinding wheels, belts, guide bearings and other related items.

Seller shall in no event be liable for death, injuries to persons or property, or for incidental, contingent, special, or consequential damages arising from the use of our products.

To take advantage of this warranty, proof of purchase documentation must be provided which has the date of purchase and an explanation of the complaint.

The Seller reserves the right to effect at any time, without prior notice, those alterations to parts, fittings, and accessory equipment which they may deem necessary for any reason whatsoever.

To register your machine online, visit RIKON at www.rikontools.com/warranty

To take advantage of this warranty, or if you have any questions,
please contact us at 877-884-5167 or email warranty@rikontools.com

TROUBLESHOOTING



WARNING

FOR YOUR OWN SAFETY, ALWAYS TURN OFF AND UNPLUG THE MACHINE BEFORE CARRYING OUT ANY TROUBLESHOOTING.

SYMPTOM	POSSIBLE CAUSES	SOLUTIONS
Machine will not start.	<ol style="list-style-type: none"> 1. No power 2. Blown fuse 3. ON / OFF switch not functioning 4. Motor failure 	<ol style="list-style-type: none"> 1. Check power source, plug and wiring. 2. Check fuse, replace if it is blown. 3. Check position of the switch. Contact local dealer for repair or replacement. 4. Inspect motor for failed components. Contact Dealer for repair or replacement.
Circuit Breakers trip and /or Fuses are blown	<ol style="list-style-type: none"> 1. Wrong circuit size for the machine 2. Motor is overloaded under strain from taking too heavy of cut 3. Use of an extension cord 	<ol style="list-style-type: none"> 1. Check circuit/fuse rating and amps of the motor. Install CORRECT rated breaker/fuse. 2. Take lighter cuts in planing lumber. 3. No extension cord, or use heavier gauge cord.
Machine bogs down in the cut	<ol style="list-style-type: none"> 1. Excessive depth of cut 2. Feed rate is too fast 3. Knives are dull 	<ol style="list-style-type: none"> 1. Decrease depth of cut. 2. Reduce feed rate. 3. Replace or sharpen knives.
Cutting rate is not consistent	<ol style="list-style-type: none"> 1. Belts are loose 2. Chips and dust build-up on parts 	<ol style="list-style-type: none"> 1. Check pulleys and belts for tension & wear. 2. Unplug machine and clean all parts.
Jointer fence is not accurate at 90° or 45°	<ol style="list-style-type: none"> 1. Fence stops are not properly adjusted 2. Locking handles are loose 	<ol style="list-style-type: none"> 1. Readjust the fence stops. 2. Check all handles to make sure that they are properly tightened before starting the machine.
'Chatter' marks on lumber	<ol style="list-style-type: none"> 1. Feed rate is too fast 	<ol style="list-style-type: none"> 1. Slow the feed rate down.
Cutterhead slows down when jointing	<ol style="list-style-type: none"> 1. Feed rate is too fast 2. Downward pressure on the cutterhead knives is too great 	<ol style="list-style-type: none"> 1. Slow down feeding the wood over the cutterhead. 2. Apply less downward pressure
Small raised lines are running along the surface	<ol style="list-style-type: none"> 1. Knives are nicked or broken 	<ol style="list-style-type: none"> 1. Rotate insert knives to new sharp edges.
Jointed stock is concave on the back end of the board	<ol style="list-style-type: none"> 1. Knives are set higher than the outfeed table 	<ol style="list-style-type: none"> 1. Raise the outfeed table level with the cutterhead & knives.
Jointed stock is concave on the front end of the board	<ol style="list-style-type: none"> 1. Outfeed table is set higher than the knives 	<ol style="list-style-type: none"> 1. Lower the outfeed table level with the cutterhead & knives.
Stock is concave in the middle of the board	<ol style="list-style-type: none"> 1. Table is out of level 	<ol style="list-style-type: none"> 1. Raise the table ends.
Milled surface is torn - also called 'chip out' or 'tear out'	<ol style="list-style-type: none"> 1. Cutting against the grain 2. Cut is too deep 3. Knives are dull 	<ol style="list-style-type: none"> 1. Cut with the grain. For figured woods, take shallow cuts to minimize tear out. 2. Reduce cutting depth to 1/16" or less. 3. Rotate insert knives to new sharp edges.
Milled surface grain is rough, raised or fuzzy	<ol style="list-style-type: none"> 1. Lumber has a high moisture content 2. Knives are dull 	<ol style="list-style-type: none"> 1. Reduce the moisture content by drying it, or switch to other properly seasoned lumber. 2. Rotate insert knives to new sharp edges.
Milled surface is glossy	<ol style="list-style-type: none"> 1. Cutting depth is too shallow 2. Knives are dull 3. Feed rate is too slow 	<ol style="list-style-type: none"> 1. Increase depth of cut slightly. 2. Rotate insert knives to new sharp edges. 3. Increase feed rate.

RIKON
POWER TOOLS®

20-800H



For more information:
16 Progress Road
Billerica, MA 01821

877-884-5167 / 978-528-5380
techsupport@rikontools.com



Link to RIKON website