

12" VS Drill Press



Operator's Manual

Record the serial number and date of purchase in your manual for future reference.

The serial number can be found on the specification label on the side of your machine.

Serial Number: _____ Date of purchase: _____

For technical support, email techsupport@rikontools.com - For parts questions, email parts@rikontools.com

TABLE OF CONTENTS

Specifications.....	2
Safety Instructions	3 - 6, 16
Getting To Know Your Machine	7
Contents of Package	7 - 8
Installation	8
Assembly	9 - 11
Adjustments.....	12 - 15
Operation	15 - 18
Maintenance	19
Electricals & Wiring Diagram	5 & 20
Troubleshooting	20 - 21
Notes	26
Parts Diagrams & Parts Lists	22 - 25
Accessories	27
Warranty	27

SPECIFICATIONS

Motor	3/4 HP
Motor Speed (no load).....	1,130 RPM
Volts	120 V
Amps, Hertz	5 A, 60 Hz
Swing	11-13/16" (300mm)
Chuck Size	1/32" - 5/8" (0.8 - 16mm)
Chuck Taper	JT3
Drilling Capacity	1" (25.4mm)
Spindle Travel	3-5/32" (80mm)
Spindle Taper	MT2
Head Rotates	360°
Speed Range (RPM)	Variable 150-700 & 600-2,800
Quill Diameter	1-9/16" (40mm)
Table Size	9-1/2" x 9-1/2" (240 x 240mm)
Table Tilts	90° Left & Right
Table Rotates	360°
Maximum Chuck to Table	12-13/16" (325mm)
Maximum Chuck to Base	19-1/2" (495mm)
Column Diameter	2-9/16" (65mm)
Height	38-3/16" (970mm)
Base Size	16-9/64" x 9-7/8" (410 x 250mm)
Net Weight	102.5 lbs. (46.5 Kg.)

NOTE: The specifications, photographs, drawings and information in this manual represent the current model when the manual was prepared. Changes and improvements may be made at any time, with no obligation on the part of Rikon Power Tools, Inc. to modify previously delivered units. Reasonable care has been taken to ensure that the information in this manual is correct, to provide you with the guidelines for the proper safety, assembly and operation of this machine.

SAFETY INSTRUCTIONS

IMPORTANT! Safety is the single most important consideration in the operation of this equipment. **The following instructions must be followed at all times.** Failure to follow all instructions listed below may result in electric shock, fire, and/or serious personal injury.

There are certain applications for which this tool was designed. We strongly recommend that this tool not be modified and/or used for any other application other than that for which it was designed. If you have any questions about its application, do not use the tool until you have contacted us and we have advised you.

SAFETY SYMBOLS



SAFETY ALERT SYMBOL: Indicates DANGER, WARNING, or CAUTION. This symbol may be used in conjunction with other symbols or pictographs.



Indicates an imminently hazardous situation, which, if not avoided, could result in death or serious injury.



Indicates a potentially hazardous situation, which, if not avoided, could result in death or serious injury.



Indicates a potentially hazardous situation, which, if not avoided, could result in minor or moderate injury.

NOTICE: Shown without Safety Alert Symbol indicates a situation that may result in property damage.

GENERAL SAFETY

KNOW YOUR POWER TOOL. Read the owner's manual carefully. Learn the tool's applications, work capabilities, and its specific potential hazards.

BEFORE USING YOUR MACHINE

To avoid serious injury and damage to the tool, read and follow all of the Safety and Operating Instructions before operating the machine.

1. **WARNING:** Some dust created by using power tools contains chemicals known to the State of California to cause cancer, birth defects, or other reproductive harm. Some examples of these chemicals are:

- Lead from lead-based paints.
- Crystalline silica from bricks, cement, and other masonry products.
- Arsenic and chromium from chemically treated lumber.

Your risk from these exposures varies, depending on how often you do this type of work. To reduce your exposure to these chemicals: work in a well ventilated area and work with approved safety equipment, such as those dust masks that are specially designed to filter out microscopic particles.

2. **READ** the entire Owner's Manual. **LEARN** how to use the tool for its intended applications.

3. **GROUND ALL TOOLS.** If the tool is supplied with a 3 prong plug, it must be plugged into a 3-contact electrical receptacle. The 3rd prong is used to ground the tool and provide protection against accidental electric shock. **DO NOT** remove the 3rd prong. See Grounding Instructions on the following pages.

4. **AVOID A DANGEROUS WORKING ENVIRONMENT.** **DO NOT** use electrical tools in a damp environment or expose them to rain.

5. **DO NOT** use electrical tools in the presence of flammable liquids or gasses.

6. **ALWAYS** keep the work area clean, well lit, and organized. **DO NOT** work in an environment with floor surfaces that are slippery from debris, grease, and wax.

7. **KEEP VISITORS AND CHILDREN AWAY. DO NOT** permit people to be in the immediate work area, especially when the electrical tool is operating.

8. **DO NOT FORCE THE TOOL** to perform an operation for which it was not designed. It will do a safer and higher quality job by only performing operations for which the tool was intended.

9. **WEAR PROPER CLOTHING. DO NOT** wear loose clothing, gloves, neckties, or jewelry. These items can get caught in the machine during operations and pull the operator into the moving parts. The user must wear a protective cover on their hair, if the hair is long, to prevent it from contacting any moving parts.

10. **CHILDPROOF THE WORKSHOP AREA** by removing switch keys, unplugging tools from the electrical receptacles, and using padlocks.

11. **ALWAYS UNPLUG THE TOOL FROM THE ELECTRICAL RECEPTACLE** when making adjustments, changing parts or performing any maintenance.

SAFETY INSTRUCTIONS

12. KEEP PROTECTIVE GUARDS IN PLACE AND IN WORKING ORDER.

13. AVOID ACCIDENTAL STARTING. Make sure that the power switch is in the “OFF” position before plugging in the power cord to the electrical receptacle.

14. REMOVE ALL MAINTENANCE TOOLS from the immediate area prior to turning “ON” the machine.

15. USE ONLY RECOMMENDED ACCESSORIES. Use of incorrect or improper accessories could cause serious injury to the operator and cause damage to the tool. If in doubt, check the instruction manual that comes with that particular accessory.

16. NEVER LEAVE A RUNNING TOOL UNATTENDED. Turn the power switch to the “OFF” position. **DO NOT** leave the tool until it has come to a complete stop.

17. DO NOT STAND ON A TOOL. Serious injury could result if the tool tips over, or you accidentally contact the tool.

18. DO NOT store anything above or near the tool where anyone might try to stand on the tool to reach it.

19. MAINTAIN YOUR BALANCE. DO NOT extend yourself over the tool. Wear oil resistant rubber soled shoes. Keep floor clear of debris, grease, and wax.

20. MAINTAIN TOOLS WITH CARE. Always keep tools clean and in good working order. Keep all blades and tool bits sharp, dress grinding wheels and change other abrasive accessories when worn.

21. EACH AND EVERY TIME, CHECK FOR DAMAGED PARTS PRIOR TO USING THE TOOL. Carefully check all guards to see that they operate properly, are not damaged, and perform their intended functions. Check for alignment, binding or breaking of moving parts. A guard or other part that is damaged should be immediately repaired or replaced.

22. DO NOT OPERATE TOOL WHILE TIRED, OR UNDER THE INFLUENCE OF DRUGS, MEDICATION OR ALCOHOL.

23. SECURE ALL WORK. Use clamps or jigs to secure the work piece. This is safer than attempting to hold the work piece with your hands.

24. STAY ALERT, WATCH WHAT YOU ARE DOING, AND USE COMMON SENSE WHEN OPERATING A POWER TOOL.

A moment of inattention while operating power tools may result in serious personal injury.

25. ALWAYS WEAR A DUST MASK TO PREVENT INHALING DANGEROUS DUST OR AIRBORNE PARTICLES, including wood dust, crystalline silica dust and asbestos dust. Direct particles away from face and body. Always operate tool in well ventilated area and provide for proper dust removal. Use dust collection system wherever possible. Exposure to the dust may cause serious and permanent respiratory or other injury, including silicosis (a serious lung disease), cancer, and death. Avoid breathing the dust, and avoid prolonged contact with dust. Allowing dust to get into your mouth or eyes, or lay on your skin may promote absorption of harmful material. Always use properly fitting NIOSH/OSHA approved respiratory protection appropriate for the dust exposure, and wash exposed areas with soap and water.

26. USE A PROPER EXTENSION CORD IN GOOD CONDITION. When using an extension cord, be sure to use one heavy enough to carry the current your product will draw. The table on the following page shows the correct size to use depending on cord length and nameplate amperage rating. If in doubt, use the next heavier gauge. The smaller the gauge number, the larger diameter of the extension cord. If in doubt of the proper size of an extension cord, use a shorter and thicker cord. An undersized cord will cause a drop in line voltage resulting in a loss of power and overheating.
USE ONLY A 3-WIRE EXTENSION CORD THAT HAS A 3-PRONG GROUNDING PLUG AND A 3-POLE RECEPTACLE THAT ACCEPTS THE TOOL’S PLUG.

27. ADDITIONAL INFORMATION regarding the safe and proper operation of this product is available from:

- Power Tool Institute
1300 Summer Avenue
Cleveland, OH 44115-2851
www.powertoolinstitute.org
- National Safety Council
1121 Spring Lake Drive
Itasca, IL 60143-3201
www.nsc.org
- American National Standards Institute
25 West 43rd Street, 4th Floor
New York, NY 10036
www.ansi.org
- ANSI 01.1 Safety Requirements for Woodworking Machines and the U.S. Department of Labor regulations
www.osha.gov

28. SEE PAGE 16 for LASER SAFETY INFORMATION.

29. SAVE THESE INSTRUCTIONS. Refer to them frequently and use them to instruct others.

SAFETY INSTRUCTIONS

ELECTRICAL SAFETY

⚠ WARNING: THIS 120V TOOL MUST BE GROUND-ED WHILE IN USE TO PROTECT THE OPERATOR FROM ELECTRIC SHOCK.

IN THE EVENT OF A MALFUNCTION OR BREAKDOWN, grounding provides the path of least resistance for electric current and reduces the risk of electric shock. This tool is equipped with an electric cord that has an equipment grounding conductor and requires a grounding plug (not included). The plug **MUST** be plugged into a matching electrical receptacle that is properly installed and grounded in accordance with **ALL** local codes and ordinances.

DO NOT MODIFY ANY PLUG. If it will not fit the electrical receptacle, have the proper electrical receptacle installed by a qualified electrician.

IMPROPER ELECTRICAL CONNECTION of the equipment grounding conductor can result in risk of electric shock. The conductor with the green insulation (with or without yellow stripes) is the equipment grounding conductor. **DO NOT** connect the equipment grounding conductor to a live terminal if repair or replacement of the electric cord or plug is necessary.

CHECK with a qualified electrician or service personnel if you do not completely understand the grounding instructions, or if you are not sure the tool is properly grounded when installing or replacing a plug.

USE ONLY A 3-WIRE EXTENSION CORD THAT HAS THE PROPER TYPE OF A 3-PRONG GROUNDING PLUG THAT MATCHES THE MACHINE'S 3-PRONG PLUG AND ALSO THE 3-POLE RECEPTACLE THAT ACCEPTS THE TOOL'S PLUG. *

REPLACE A DAMAGED OR WORN CORD IMMEDIATELY.

This tool is intended for use on a circuit that has an electrical receptacle as shown in **FIGURE A**. It shows a 3-wire electrical plug and electrical receptacle that has a grounding conductor. If a properly grounded electrical receptacle is not available, an adapter as shown in **FIGURE B** can be used to temporarily connect this plug to a 2-contact ungrounded receptacle. The adapter has a rigid lug extending from it that **MUST** be connected to a permanent earth ground, such as a properly grounded receptacle box. **THIS ADAPTER IS PROHIBITED IN CANADA.**

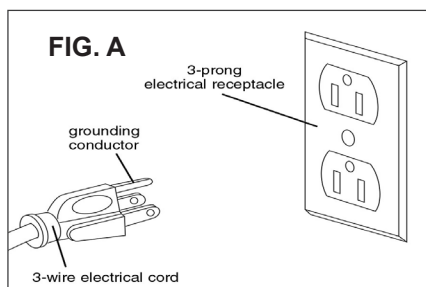

EXTENSION CORDS

⚠ WARNING: THE USE OF AN EXTENSION CORD WITH THIS MACHINE IS NOT RECOMMENDED. For best power and safety, plug the machine directly into a dedicated, grounded electrical outlet that is within the supplied cord length of the machine.

If an extension cord needs to be used, it should only be for a limited operation of the machine. The extension cord should be as short as possible in length, and have a minimum gauge size of 14AWG.

⚠ WARNING: Check extension cords before each use. If damaged replace immediately. Never use a tool with a damaged cord, since touching the damaged area could cause electrical shock, resulting in serious injury.

Use a proper extension cord. Only use cords listed by Underwriters Laboratories (UL). Other extension cords can cause a drop in line voltage, resulting in a loss of power and overheating of tool. When operating a power tool outdoors, use an outdoor extension cord marked "W-A" or "W". These cords are rated for outdoor use and reduce the risk of electric shock.

MINIMUM RECOMMENDED GAUGE FOR EXTENSION CORDS (AWG)

120 VOLT OPERATION ONLY				
	25' LONG	50' LONG	100' LONG	150' LONG
0 to 6 Amps	18 AWG	16 AWG	16 AWG	14 AWG
6 to 10 Amps	18 AWG	16 AWG	14 AWG	12 AWG
10 to 12 Amps	16 AWG	16 AWG	14 AWG	12 AWG

⚠ WARNING: Keep the extension cord clear of the working area. Position the cord so that it will not get caught on lumber, tools or other obstructions while you are working with your power tool.

* Canadian electrical codes require extension cords to be certified SJT type or better.

** The use of an adapter in Canada is not acceptable.

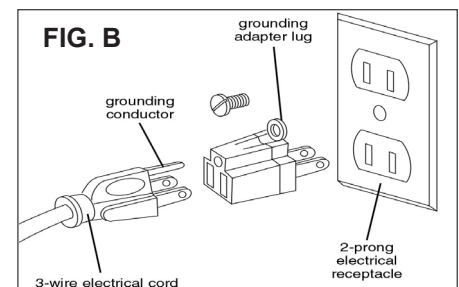

SAFETY INSTRUCTIONS

SPECIFIC SAFETY INSTRUCTIONS FOR DRILL PRESSES

This machine is intended for the drilling of wood, composite materials, plastics, ferrous and non-ferrous metals. The permissible workpiece dimensions must be observed (see Technical Specification). Any other use not as specified, including modification of the machine or use of parts not tested and approved by the equipment manufacturer, can cause unforeseen damage and invalidate the warranty.

ATTENTION: Use of this drill press still presents risks that cannot be eliminated by the manufacturer. Therefore, the user must be aware that wood working machines are dangerous if not used with care and all safety precautions are adhered to.

1. Do not operate the Drill Press until it is assembled and you have read all of the instructions.
2. Do not operate the Drill Press unless you are familiar with its safe operation. If you are not familiar with the operation of a Drill Press seek advice from your supervisor, instructor or other qualified individual.
3. If you are using a bench top Drill Press, it must be securely fastened to a stand or bench.
4. If you are operating a floor Drill Press it must be securely fastened to the floor.
5. Always clear the table and work area before turning on the Drill Press.
6. Always use drill bits, cutting tools and accessories with a 1/2" shank or less.
7. Never place hands near the drill bit, cutting tool or accessory while operating the Drill Press.
8. Always wear approved, safety eye wear and hearing protection while operating the Drill Press.
9. Never wear loose clothing, gloves or ties while operating the Drill Press. Tie loose hair back.
10. Always wear a dust mask and use adequate dust collection and proper ventilation.
11. Always have a firm footing while operating the Drill Press.
12. Always keep the work surface and work areas clear of debris.
13. Never attempt to do set-up work, assembly or layout work on the Drill Press while it is in operation.
14. Never look directly into the laser beam or use optical tools to view the laser beam. Eye injury could result.
15. Always lock all table, column and head locks before turning on the Drill Press.
16. Never start the Drill Press with the drill bit, cutting tool or accessory in contact with the work piece.
17. Never operate the Drill Press with a damaged drill bit, cutting tool or accessory.
18. Always check that the drill bit, cutting tool or accessory is held tight in the chuck.
19. Never operate the Drill Press with the chuck key in the chuck.
20. Always adjust the depth stop to avoid drilling into the table surface.
21. Never drill material unless it is properly supported. Non flat work pieces require additional support.
22. Always clamp the work piece to the table.
23. Always support large work pieces at the same height as the table.
24. Never remove the work piece or clear the table until the Drill Press comes to a complete stop.
25. Never operate the Drill Press with missing, damaged, worn, loose or defective parts.
26. Never adjust, change speeds or perform maintenance on the Drill Press while it is operating.
27. Always clean the work surface and work area when finished operating the Drill Press.
28. Always disconnect the power when adjusting or performing maintenance on the Drill Press.
29. Always disconnect the power when finished using the Drill Press to prevent accidental operation.
30. See page 16 for Laser Safety Information.

SAVE THESE INSTRUCTIONS. Refer to them often.

This manual is not a teaching aid and is only intended to show assembly, adjustments, and general use.

California Proposition 65 Warnings



WARNING: Drilling, sawing, sanding or machining wood products can expose you to wood dust, a substance known to the State of California to cause cancer. Avoid inhaling wood dust or use a dust mask or other safeguards for personal protection. For more information go to www.P65Warnings.ca.gov/wood



WARNING: This product can expose you to chemicals including Lead, which is known to the State of California to cause cancer, and Dibutyl phthalate, which are both known to the State of California to cause birth defects or other reproductive harm. For more information go to www.P65Warnings.ca.gov.

GETTING TO KNOW YOUR MACHINE

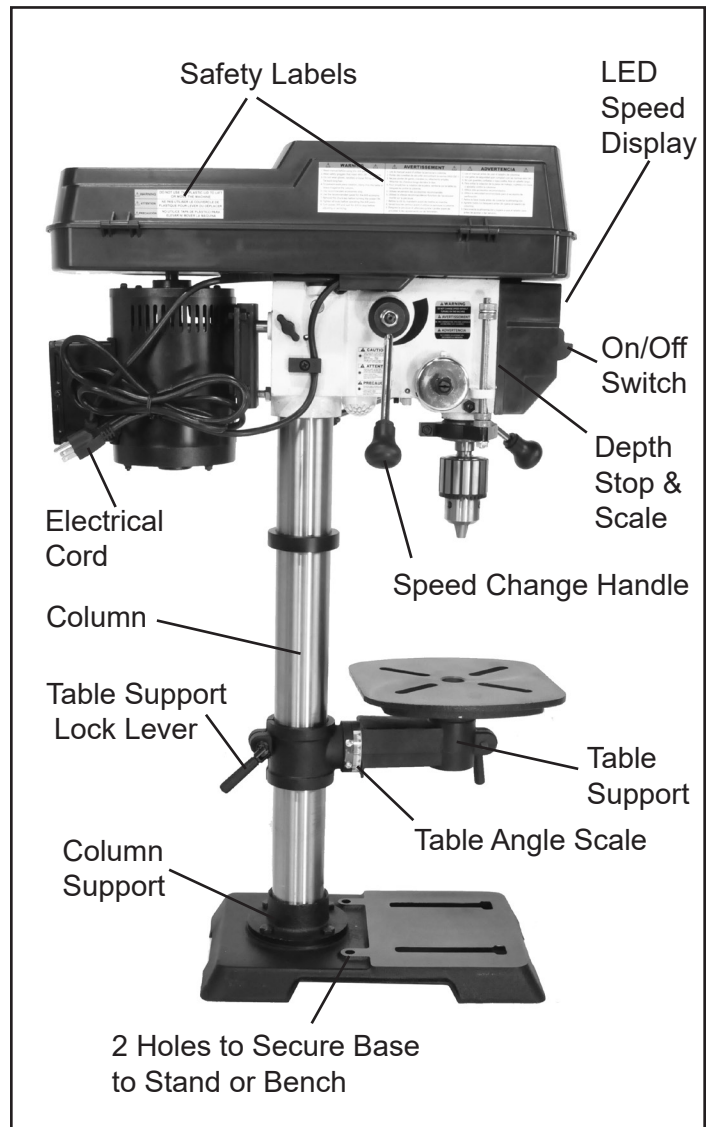
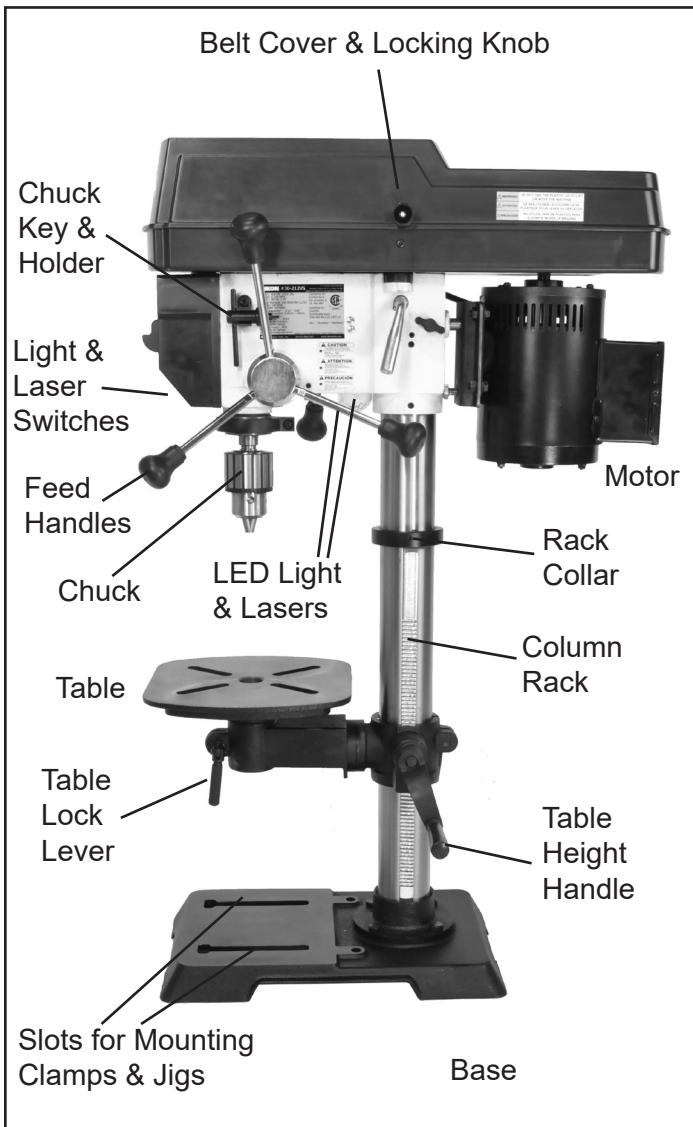

CONTENTS OF PACKAGE

Model #30-212VS 12" Variable Speed Drill Press is shipped complete in one box.

Unpacking and Clean-up

1. Carefully remove all contents from the shipping carton. Compare the contents with the list of contents to make sure that all of the items are accounted for, before discarding any packing material. Place parts on a protected surface for easy identification and assembly. If any parts are missing or broken, please call RIKON Customer Service (877-884-5167) as soon as possible for replacements. DO NOT turn your machine ON if any of these items are missing. You may cause injury to yourself or damage to the machine.
2. Report any shipping damage to your local distributor. Take photographs for any possible insurance claims.
3. Clean all rust protected surfaces with ordinary house hold type grease or spot remover. Do not use; gasoline, paint thinner, mineral spirits, etc. These may damage painted surfaces.
4. Apply a coat of paste wax to the table to prevent rust. Wipe all parts thoroughly with a clean dry cloth.
5. Set packing material and shipping carton aside. Do not discard until the machine has been set up and is running properly.

CONTENTS OF PACKAGE

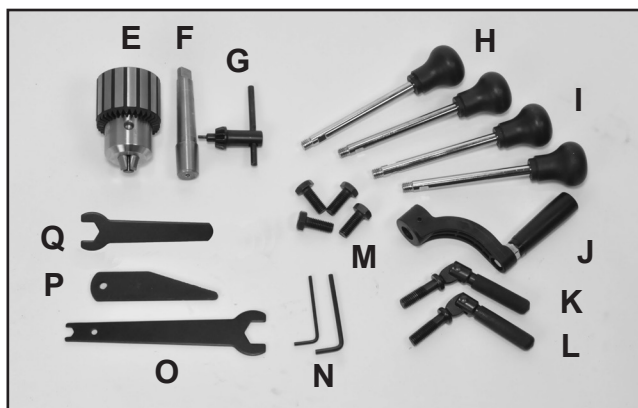
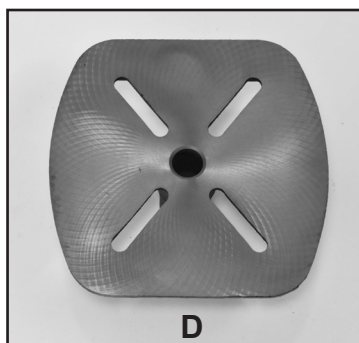
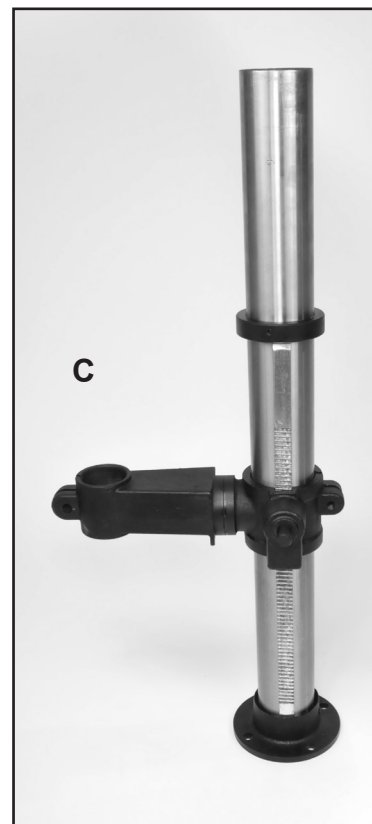

LIST OF LOOSE PARTS

- | | |
|----------------------|---------------------------------------|
| A. Head Assembly | J. Crank Handle |
| B. Base | K. Table Bracket Lever Handle |
| C. Column Assembly | L. Table Arm Lever Handle |
| D. Table | M. Hex Head Bolts (4) |
| E. 5/8" Chuck | N. Hex Wrenches - 3 & 4mm |
| F. Arbor JT3 - MT2 | O. Special Wrench - 19mm / 8 mm |
| G. Chuck Key | P. Drift Wedge |
| H. Speed Handle | Q. 16mm Wrench |
| I. Drive Handles (3) | R. Manual & Warranty Card (not shown) |

Tools Needed for Assembly

- Phillips Screwdriver
- 10mm, 16mm or Adjustable Wrench
- Rubber Mallet or Hammer & Block of Wood

INSTALLATION

MOVING & INSTALLING THE DRILL PRESS

1. **CAUTION** When moving the Drill Press, hold both the column and under the drill press base to lift and move the machine. The drill press head with motor is top heavy and must remain upright to avoid tipping.

DO NOT use the plastic lid assembly at any time to move the tool!

DO NOT move or carry the Drill Press with the work table, chuck or operating handles, as this may also damage the machine.

2. Secure the machine onto a solid stand, or bench, that is located in an area that has ample space in front and at both sides for working and moving work pieces around the drill press.

3. For best power and safety, the machine should be plugged directly into a dedicated grounded electrical outlet that is within the supplied cord length of the machine. The use of an extension cord is not recommended.

4. Align the machine so that during use, any projects, debris or kickback will not face aisles, doorways, or other work areas that bystanders may be in. Do not locate or use the machine in damp or wet conditions.

5. Once in place in your shop, make sure that the machine is level. Secure the machine to a bench or stand, with lag screws or bolts (not supplied). This will eliminate any tipping over of the drill press, and reduce any possible vibration during use.

ASSEMBLY

BASE AND COLUMN ASSEMBLY

1. Place the Base (Part #1, Figure 1, A) on a level floor where the machine will be used. FIG. 1.

2. Attach the Column (#2 & 5, B) to the base using four M10x25 hex Bolts (#4). Tighten all four bolts.

NOTE: The column is shipped with the toothed Rack (#6), Collar Rack (#7) and Table Arm Assembly (#10-18) pre-assembled on the column. The column should be positioned on the base with the table arm facing forward with the rack to the right side of the column.

3. Check the Hex Screw (#3) on the side of the support column (B), and the Hex Screw (#8) on the Collar Rack (#7) to make sure that they are secure.

INSTALLING THE HANDLES & TABLE

1. Install the large Locking Lever Handle (#9) onto the rear joint of the table support bracket. Slide the handle through the un-threaded hole on the bracket casting. The handle will engage the threading on the other side of the hole in the casting, then tighten the locking lever to secure the bracket in place on the column. FIG. 2.

2. Install the table raising/lowering Crank Handle (#19) to the side shaft of the Table Support (#10) with a hex wrench. FIG. 3.

3. If not pre-installed at the factory, install the small Locking Lever (#9, Fig. 4, A) onto the front joint of the Table Support Bracket (#15, B). FIG. 4.

4. Insert the table's (#20) post (C) into the table support bracket (B) as shown in Figure 4. Tighten the locking lever (A) to secure the table in position.

NOTE: Parts referenced throughout the manual refer to the identification key numbers of the Parts Diagrams and Parts Lists on pages 22 to 25.

⚠ WARNING THE MACHINE MUST NOT BE PLUGGED IN AND THE POWER SWITCH MUST BE IN THE OFF POSITION UNTIL ASSEMBLY IS COMPLETE.

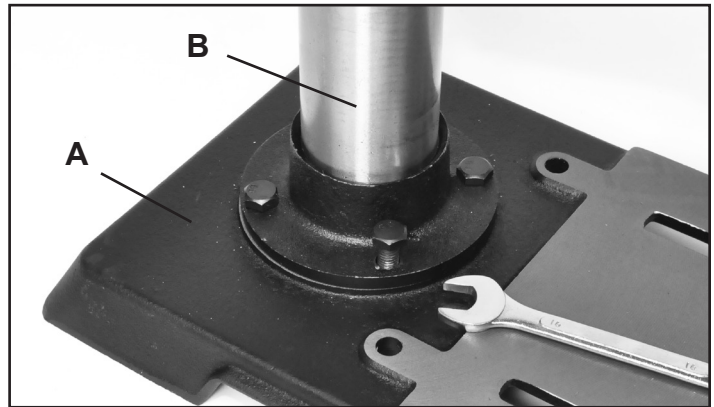

FIG. 1

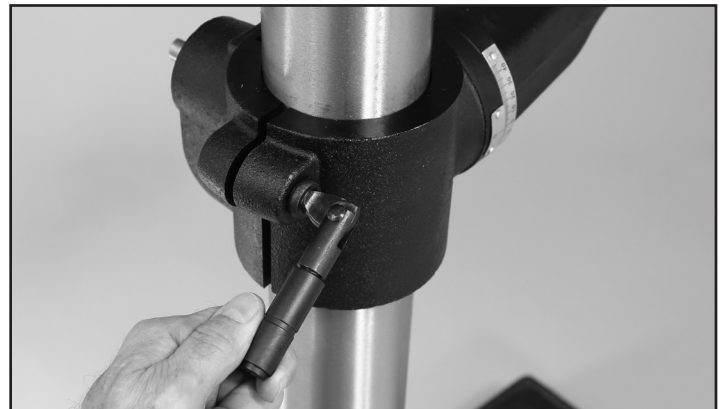

FIG. 2



FIG. 3

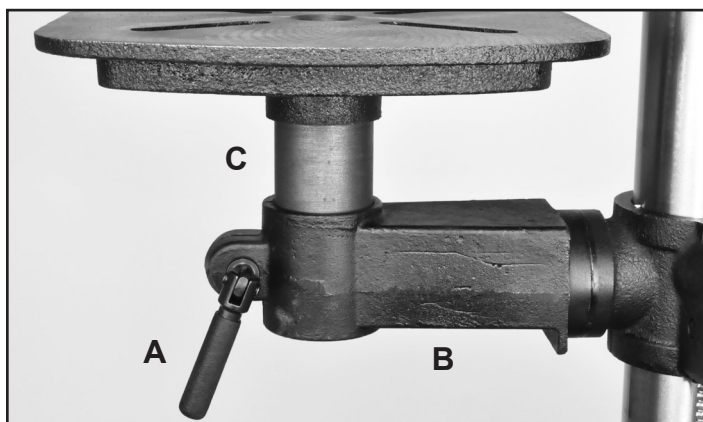

FIG. 4

CONTINUED ON THE NEXT PAGE

ASSEMBLY

⚠ WARNING THE MACHINE MUST NOT BE PLUGGED IN AND THE POWER SWITCH MUST BE IN THE OFF POSITION UNTIL ASSEMBLY IS COMPLETE.

HEAD ASSEMBLY

⚠ CAUTION Assistance is needed for this next step.

1. Carefully lift and place the drill press head onto the top of the column. It should slip down until the column stops against the inside end of the head casting hole. Swivel the drill press head until it is in line with the base and table, with the control panel facing forward. FIG. 5.

2. Secure the drill press head to the column by tightening the two set screws (#3) on the right side of the head. FIG. 6, A.

3. If not pre-installed at the factory, install the small, pulley cover Knob (#109) onto the right side of the top lid. Open the belt cover and insert the machine Bolt (#108) through the hole in the lid from the inside. Place the knob on the bolt, outside of the belt cover, and fasten it in place with Nut (#110). Secure the cover in place by rotating the knob. FIG. 6, B.

4. Install the three feed Handles (#58) into the pre-threaded holes in the Handle Seat (#86). Use the 8mm end of the Special Wrench (#131) to secure the handles in place. FIG. 7.

NOTE: Figures 6 & 7 also show the motor Lock Knobs (#67, C), Tension Lever (#89, D) and the motor Mount Assembly (E) that are referenced in the section on Changing Drill Speeds on page 14.

5. On the left side of the drill press head, install the Motor Speed Handle (#58) onto the Handle Seat (#61). Secure with the 8mm wrench. FIG. 8.

IMPORTANT! The machine **MUST** be running to change the speeds of the drill press.

In cold temperatures when work is done, stop the machine at the **LOW SPEED** setting, so when next used, the Drill Press will start in Low Speed. Then it can be adjusted to the RPM speed you desire. This process will help the motor start more efficiently in the cold, by putting less strain on the electrical components.



FIG. 5



FIG. 6

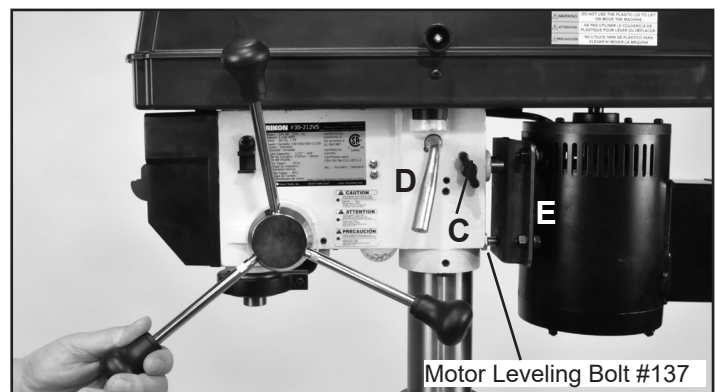

FIG. 7



FIG. 8

ASSEMBLY

INSTALLING & REMOVING THE CHUCK

IMPORTANT! It is important that the tapered hole in the chuck, tapered hole in the spindle and both tapered ends of the arbor are free of any grease, oil, lacquer or rust protection.

These tapered surfaces must be absolutely clean for a precision fitting of the parts, so slipping of the chuck during use does not occur unless there is extreme rotational pressure during use. This is a safety feature of this type of friction fit joint.

INSTALLING THE CHUCK

1. Carefully insert the arbor's short, JT3 tapered end into the rear tapered hole of the chuck. FIG. 9.
2. Next, take the chuck and insert the long, MT2 tapered end of the arbor into the drill press spindle's tapered hole. Make sure to align the flat part of the arbor with the slot in the spindle. FIG. 10.
3. Open the jaws of the chuck until the 3 jaws are completely hidden inside of the chuck body.
4. Using a rubber mallet, or hammer with a block of wood protecting the chuck, tap the chuck with its arbor into the drill press spindle. This will securely seat the chuck in place for drilling. FIG. 11.

CAUTION NEVER HIT THE CHUCK WITH A METAL HAMMER. This could damage the chuck assembly, arbor or drill press spindle.

REMOVING THE CHUCK

1. Open the chuck jaws as wide as possible to prevent damage in the following steps.
2. Lower the spindle (#21) until the slot in the spindle is exposed, and lock the spindle in place with the lower, Depth Stop Nut (#31). FIG. 12.
3. Turn the chuck until the slots in the spindle and Quill (#27) align, and a through-hole is exposed.
4. Insert the Key-Drift (#132), into the slots and hole above the chuck arbor, with the drift's flat side up.
5. Gently tap the key-drift with a mallet to release the chuck. **NOTE:** Be prepared to catch the chuck as it is released to prevent any damage to it or the arbor.

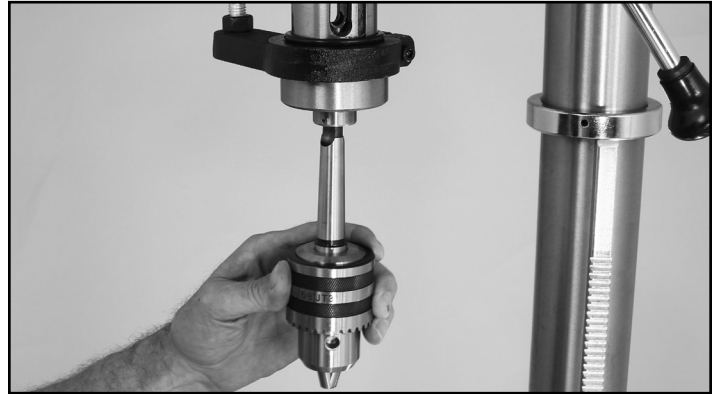

FIG. 9

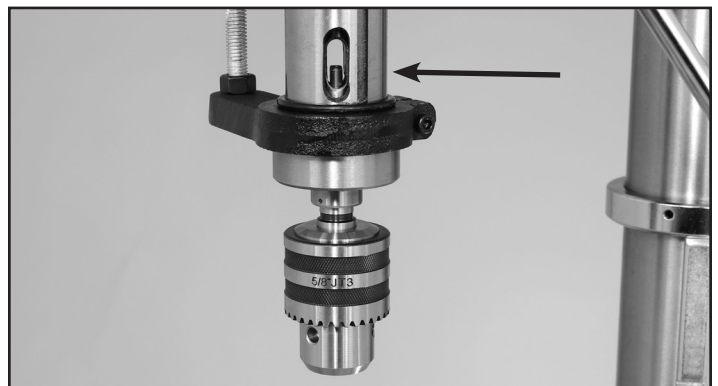

FIG. 10



FIG. 11



FIG. 12

ADJUSTMENTS

ADJUSTING THE TABLE

1. *TO RAISE OR LOWER THE TABLE* along the column, the Locking Handle (#9) must be loosened. FIG. 13, A.

2. Use the Crank Handle (#19, B) to raise or lower the work table to the height that you need.

NOTE: Always *raise* the table to your final height so that the gears mesh together best to prevent slippage.

3. When the table is at the proper height, tighten the Locking Handle to secure the table in position.

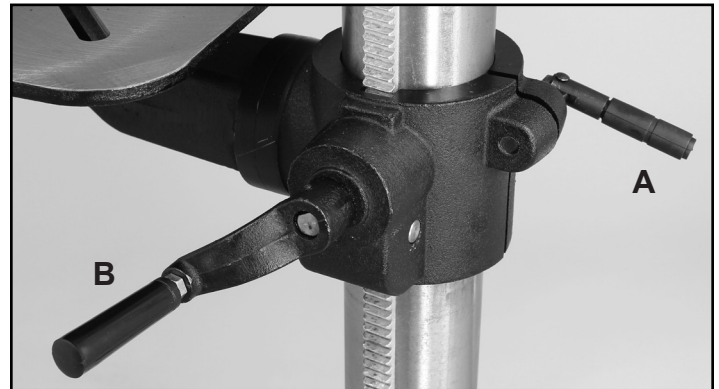

FIG. 13

4. *TO ROTATE THE TABLE* left or right, loosen the Locking Handle (#9) that is positioned directly below the table. FIG. 14, C.

NOTE: If needed for special drilling or project clamping applications, the whole table assembly can be swiveled 360° around the column. Loosen the Set Screw (#8) on the Collar Rack (#7), Locking Handle (#9) and carefully rotate the table assembly with the rack around the column to the location you need. Then re-tighten the set screws and lever to secure the parts in the new position on the column.

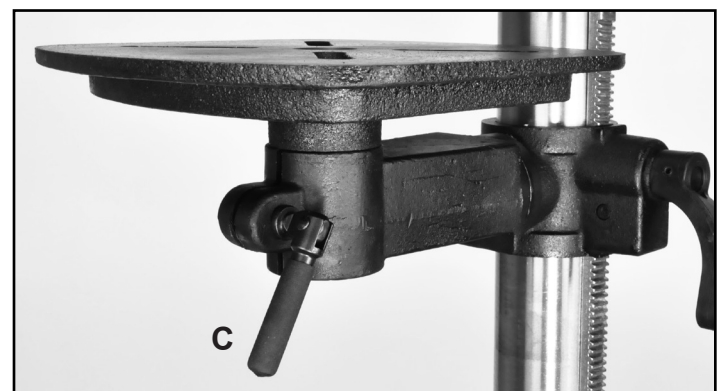

FIG. 14

5. *TO TILT THE TABLE* on an angle, the table and support arm assembly move together. Loosen the large Hex Bolt (#14) with the 19mm Special Wrench provided. FIG. 15 & 16.

6. The table and support arm can be tilted left or right. An Angle Scale (#15A) is provided on the casting to indicate the degree of tilt of the table. FIG. 15. When the desired table tilting angle is found, the large bolt needs to be tightened.

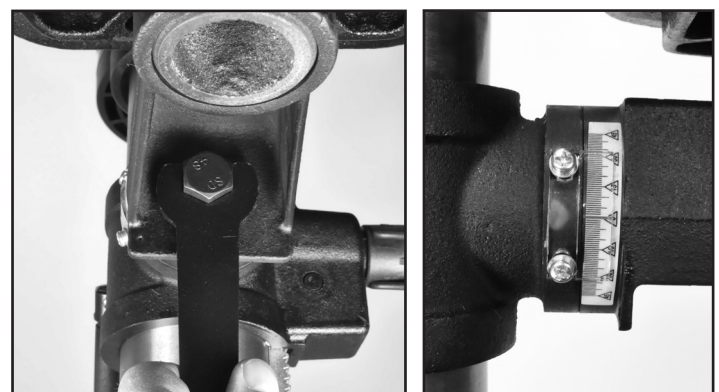

FIG. 15

7. To return the table to the level position, 90° to the spindle, loosen the large bolt secured in step 5. Rotate the table assembly until the angle scale cursor lines up with the 0° mark. Then re-tighten the large bolt on the support arm.

8. *TO SET THE TABLE TO HORIZONTAL*, or 90° to the Quill, use a mechanic's square. Set the square on the table and position it against a twist drill bit that is held in the chuck. Adjust the table angle as needed to set it at the horizontal 90° position.

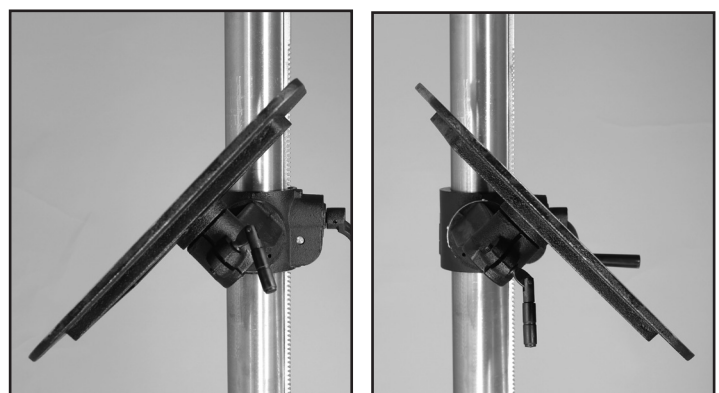

FIG. 16

ADJUSTMENTS

ADJUSTING THE DEPTH STOP

The Depth Stop is used for boring multiple holes at the same, identical depth. The threaded rod includes a scale and a large quick release nut for fast setting of the depth that the spindle/chuck will travel. FIG. 17.

The chuck's travel distance/depth is read on the scale at the bottom of the upper Depth Setting Nuts (#31). Example: At reading '2 inch', the Depth Setting Nuts should be set down the scale as shown in FIG. 17.

Setting the a specific depth can be done in 2 ways:

THE DEPTH SCALE METHOD

1. With your workpiece on the table, raise the table until the surface of the workpiece touches the drill bit that is in the chuck. Lock the table in position.
2. Adjust the Depth Setting Nuts to the desired depth on the threaded rod's scale. **NOTE:** Depth is read at the **BOTTOM** of the lower nut. FIG. 18.
3. Drill a test hole to check the depth setting, and adjust the depth setting as necessary. It is best to use a scrap piece of wood, that is the exact same thickness of your workpiece, for test drilling to ensure the proper results. **NOTE:** See page 17 for instructions on installing drill bits in chucks.

THE WORKPIECE METHOD

1. Mark a line on the side of a workpiece at the desired depth needed.
2. Lower the drill bit that is in the chuck along the side of the workpiece, until it aligns with the drawn line. FIG. 19.

NOTE: The machine must be OFF for this procedure.

3. Holding the drill bit at the desired depth, lower the Depth Setting Nuts until they rest down on the cast metal Depth Plate that extends out from the head casting and that the depth scale moves through. The drilling depth is now set.

4. Drill a test hole to check the depth setting, and adjust as necessary. It is best to use a scrap piece of wood that is the exact same thickness of your workpiece for test drilling, to ensure the proper results.

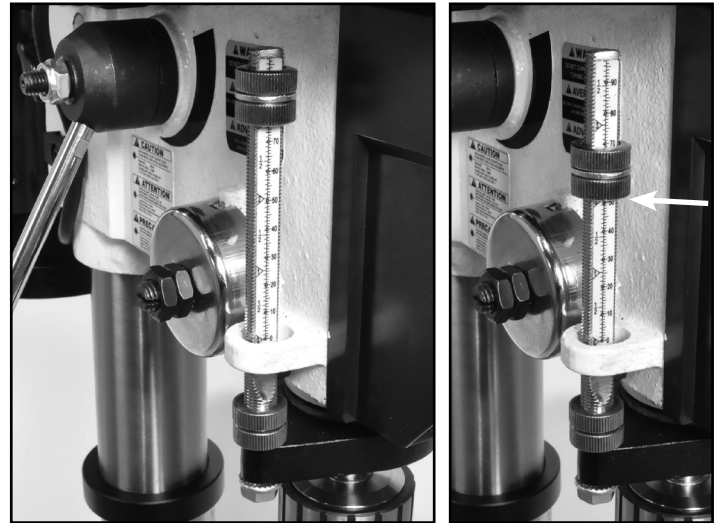

FIG. 17

⚠ WARNING THE MACHINE MUST NOT BE PLUGGED IN AND THE POWER SWITCH MUST BE IN THE OFF POSITION UNTIL ALL ADJUSTMENTS ARE COMPLETE.

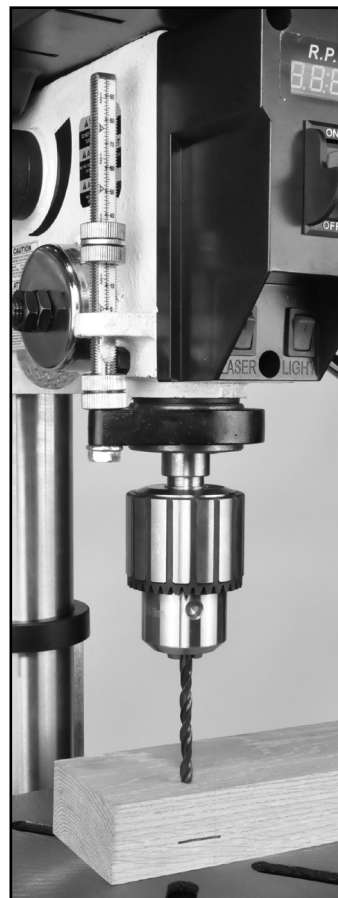

FIG. 18



FIG. 19

ADJUSTMENTS

ADJUSTING THE QUILL HEIGHT

The Quill (#27, Fig. 20, A) can be set to a particular depth or position with the lower, Scale Nut (#31, B) on the Depth Threaded Rod (#32, C). This nut is located under the cast metal Depth Plate (Fig. 20, D).

1. Lower the Quill/Chuck to the depth that is desired with the feed handles.
2. Turn the lower Scale Nut (B) up the Threaded Rod (C) until it stops up against the Depth Plate (D).
3. Release your hold on the drill press' feed handles and the Quill with chuck will stay in the set position.

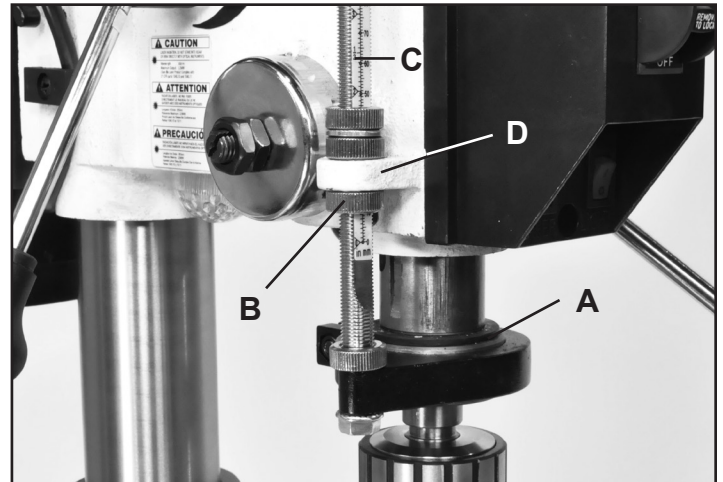

FIG. 20

ADJUSTING THE DRILL SPEED

CAUTION The Drill Press motor **MUST** be operating before changing the speeds is done, or damage to the speed adjustment mechanisms may result.

1. To adjust the operating speeds while the drill press is running, rotate the Speed Handle Lever (#58, Fig. 21, C) until the desired speed is shown on the LED display (D) on the machine front. FIG. 21.
 - Move the lever FORWARD to increase speed.
 - Move the lever BACKWARD for slower speeds.

This Drill Press has two variable speed ranges from 150 to 700 and 600 to 2,800 RPM. To change from one speed range to the other, only the rear Drive V-Belt (#80) needs to be re-positioned on the pulleys.

2. Set the drill press at the lowest speed in the range that the drill press is currently set at (low or high).
3. Loosen the belt tension by moving the motor closer to the head casting. Loosen the two Lock Knobs (#67) and with 16mm wrench turn the motor plate's leveling Bolt (#137) clockwise until it stops back against the motor mount. Then pull the Tension Lever (#89) forward to shift the motor mount assembly forward. See page 10, Figures 6 & 7 for photos identification of these parts.
4. Move the V-Belt on the rear and center pulleys to set the drill press speeds as shown to the right;
 - LOW SPEED - Belt is on the large, lower step on the center pulley to the small step on the rear pulley.
 - HIGH SPEED - Belt is on the small, top step on the center pulley to the large, top step on the rear pulley.

5. Reset the Belt tension by moving the motor back from the head casting by reversing the steps in #2.

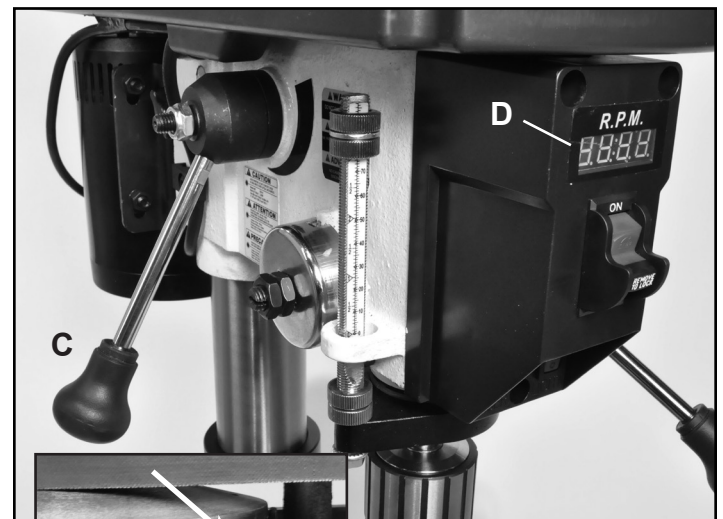
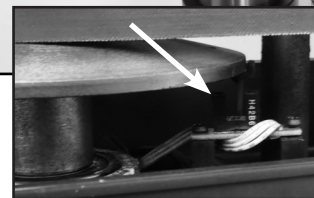
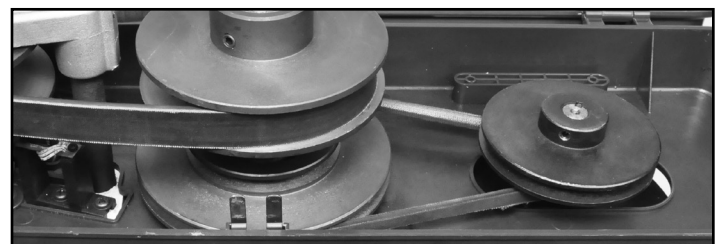

FIG. 21



RPM Reader
Under the
Front Pulley



Belt Position on Pulleys at Low Speed



Belt Position on Pulleys at High Speed

ADJUSTMENTS

ADJUSTING THE SPINDLE RETURN SPRING

The Chuck will automatically return upward to its original starting position when the operating handle is released. The Return Spring Mechanism, FIG. 22, has been preset at the factory and should not require any adjustments. However, should the spring tension decline and need adjustment, follow these steps;

1. Disconnect the Drill Press from its power source.
2. Loosen the Spring Cover Nuts (#47, FIG. 22, A), but **DO NOT REMOVE** the nuts from the threaded pin.
3. Carefully pull out the Spring Cover (#48, Fig. 22, B) slightly, and keep a firm grasp on it - **DO NOT LET THE COVER SPIN** as it keeps the spring from unwinding. Also, **DO NOT** let the spring end (C) disengage from its notch in the spring cover!
4. Pull out the cover just enough so that the notch in the cover clears the nub on the head casting (D).

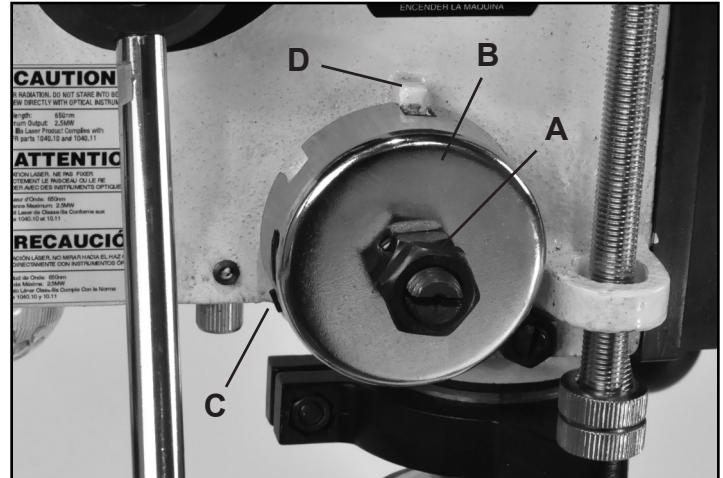

FIG. 22

5. Rotate the cover to another notch as needed - **CLOCKWISE** to decrease the spring tension, and **COUNTER-CLOCKWISE** to increase spring tension.
6. With the cover set in the new position, push it back in place and tighten the spring cover nuts back against the cover to complete the adjustment.

OPERATION

CONTROL PANEL

ON/OFF SWITCH. The ON/OFF safety switch is located on the front of the drill press head for quick, easy and safe access. FIG. 23, A.

1. Turn the machine “ON” by moving the power switch to the up position. The RPM speed can then be increased to the desired speed for the particular drilling job, or material being worked, by rotating the Speed Control Handle on the left side of the head.
2. Before turning the drill press OFF, it is recommended to turn the RPM Speed down to its slowest RPM setting to prepare the machine for its next use. Then move the power switch down to the OFF position.
3. Unplug the Drill Press from the power source when the machine is not in use, for safety measures.

NOTE: To prevent unauthorized use of the machine, the power switch has a removable locking key. With the power switch in the “OFF” position, pull the locking key out. The drill press cannot be turned “ON” with the key removed. Insert the locking key back into the power switch to resume drilling operations.

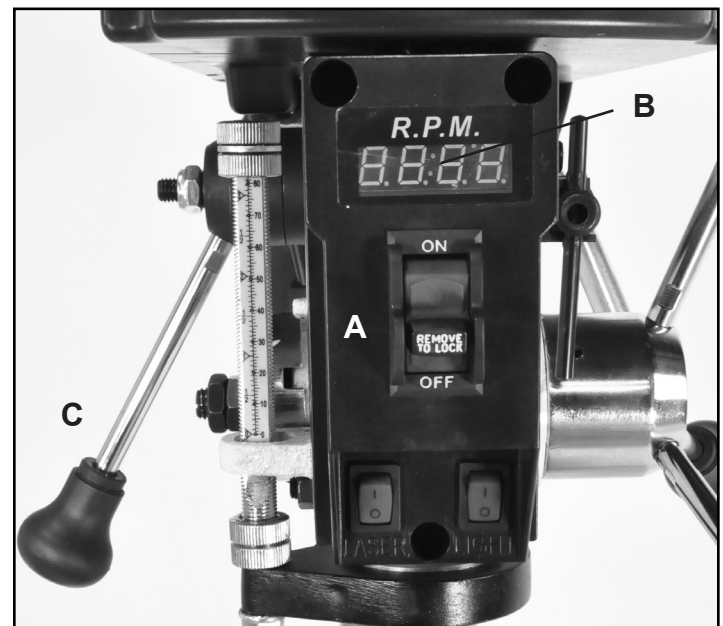

FIG. 23

SPEED RPM DIGITAL READOUT (B) displays the Chuck’s RPM as set by the Motor Speed Handle (C) (see page 14). **NOTE:** Speeds indicated may fluctuate slightly during use, as the RPM reader is constantly calibrating the spindle rotation.

OPERATION

LED LIGHT SWITCH The drill press includes a special LED Bulb (#53) that is located under the head casting by the column to best light your work from behind to eliminate shadow interference (FIG. 25, A). The light's ON/OFF switch is located on the lower front of the drill press head, the switch on the right side. FIG. 24, B.

LASER LIGHT SWITCH is also located on the lower front panel to the left of the LED light switch (FIG. 24, C). This switch activates the two X-Y laser pointers (#51) that are safely located under the head casting behind the chuck. FIG. 25, D.

LASER ADJUSTMENT The two lasers produce red lighted lines in a crossing X-Y pattern down onto your work that is resting on the drill press table. These intersecting lines indicate the center point where your drill bit will bore into your work. A very useful aid when setting up projects for precision drilling.

The lasers are pre-set at the factory, but they should be checked for alignment and adjusted each time they are used for drilling. Long term machine vibration may cause the lasers to become misaligned which can spoil projects if not fixed.

1. Prepare your drill press for drilling. The table should be in a horizontal position and locked in place.
2. Install a small diameter drill bit into the chuck. See page 17 for instructions on this process.
3. Securely clamp a flat board onto the table.
4. Plug in the drill press, turn it on and drill a small hole in the board that is clamped to the table. This tiny hole will be your reference spot for aligning the lasers.
5. Turn on the lasers with the front switch to activate the two light beams. If the intersecting beams do not precisely cross at the drilled hole, then they need to be adjusted.
6. Each laser setting is secured with a hex screw (#8) located on the side of the head casting - just behind the Handle Hub (#86) or Spring Cap (#61). FIG. 25, E. With the supplied 3mm hex wrench, loosen the hex screws so the lasers can be adjusted.
7. Turn the knurled housing of each of the lasers to position the beams exactly onto the drilled hole in the board. The two beams should form cross hairs. Once set, secure the lasers in position by re-tightening the hex screws that were loosened in step 6. The lasers are now calibrated and the X-Y cross hairs will indicate the center spot for future drilling. FIG. 26.

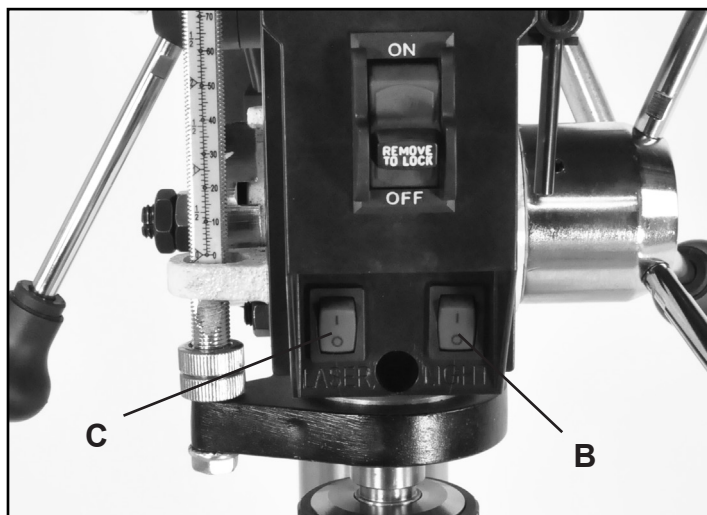

FIG. 24

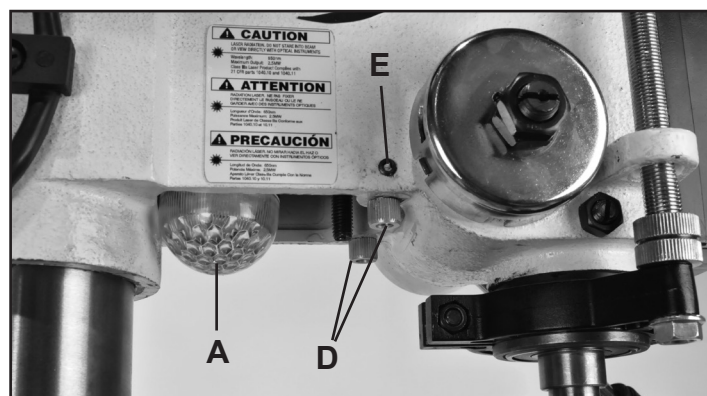

FIG. 25

CAUTION LASER RADIATION EXPOSURE.

- Do not look directly into the laser beams or view them directly with optical instruments.
- Do not disassemble or modify the lasers.
- Do not operate lasers around children.
- Turn off lasers when not in use.

CAUTION

LASER RADIATION. DO NOT STARE INTO BEAM OR VIEW DIRECTLY WITH OPTICAL INSTRUMENTS



Wavelength: 650nm
Maximum Output: 2.5mW
Class IIIa Laser Product Complies with
21 CFR parts 1040.10 and 1040.11

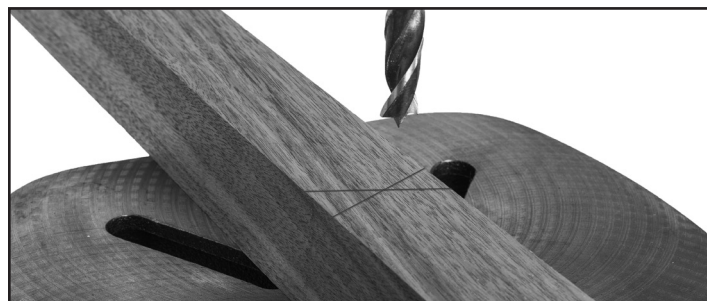

FIG. 26

OPERATION

INSTALLING AND REMOVING DRILL BITS

The 30-212VSR Drill Press includes a 3-jaw keyed chuck for the holding of drill bits with shanks up to 5/8" diameter (1/32"-5/8" / 0.8 -16mm). To install a drill bit;

1. Disconnect the machine from the power source and make sure that the switch is in the OFF position.
2. With the chuck key, turn the upper, knurled section of the chuck to open the three chuck jaws. FIG. 27.
3. Insert the shank of the drill bit into the chuck as far as it will go, or up to the beginning of the flutes that are in the drill bit.
4. Make sure that the drill bit is centered in the jaws, and with the supplied chuck key, insert the key into one of the chuck barrel's three holes and surrounding teeth. Turn the key to tighten the chuck jaws and secure the drill bit shank in place. Remove the key and repeat this tightening on the other 2 chuck holes.
5. To remove a drill bit from the chuck, reverse the chuck tightening operation detailed in step 4 above.

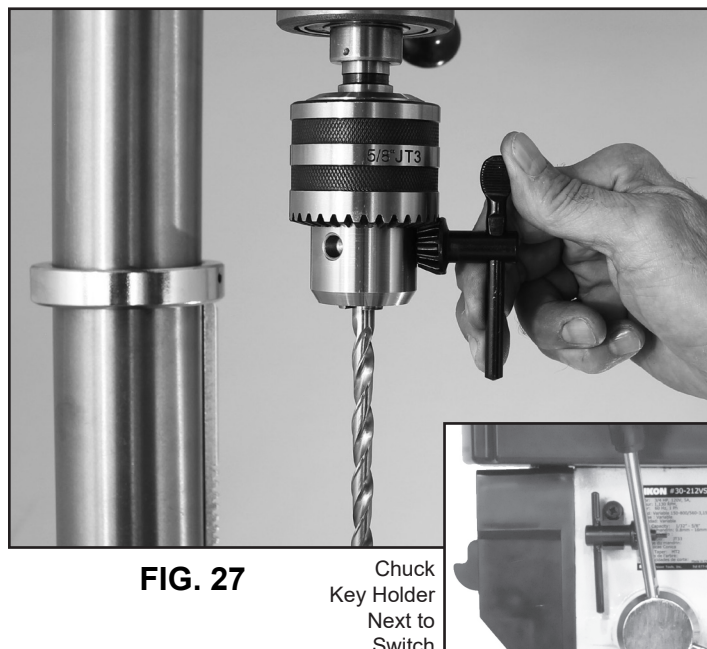

FIG. 27

Chuck
Key Holder
Next to
Switch

⚠ WARNING: DO NOT run the drill press to open or close the chuck when installing or removing a drill bit.

⚠ WARNING: Make sure that the drill bit is secure in the chuck, and the chuck key has been removed from the chuck before starting the drill press.

DRILLING SPEEDS

This Drill Press has two variable speed ranges from 150 to 700 and 600 to 2,800 RPM. The correct drilling speed for your work depends on a variety of factors:

- a) the workpiece material & hardness
 - wood, composites, plastics or metal
- b) the size of hole diameter
- c) the depth of the hole
- d) the type of drill bit or other cutter needed to make the desired hole diameter and depth
- e) the quality of the bore

We recommend consulting various books, magazine articles, drill bit and material manufacturers' information for information on the proper operating speeds and types of drills for the material or hole desired.

- A general rule: The larger the hole and the harder the material = the slower the RPM speed.

NOTE: See pages 6 and 18 for important safety information on drilling set-ups, speeds and procedures.

WORKPIECE POSITIONING

⚠ WARNING: Always use clamps or hold-downs to secure the material onto the drill press table during drilling. This will prevent the work from being torn from the operator's hand should the drill bit gets caught in the material. Clamping the work to the table is particularly necessary if the table is tilted on an angle.

Place a scrap board or piece of plywood under your work to protect the metal table, drill bit, and to provide a solid base for a clean hole if the drill bit exits the work.

To prevent work from spinning, if possible, position the work to rest against the left side of the column. For shorter pieces, use a clamp or drill press vise secured to the table.

Feed bits into the material at a constant rate to allow the bit to work. Too slowly may cause the wood to burn and ruin the bit. Too fast may put excessive stress on the motor and cause the bit to break.

OPERATION

IMPORTANT! It is strongly recommended that you read books, trade magazines, or get formal training to maximize the potential of using your Drill Press, while also minimizing the risks. Before turning on the machine, review the safety precautions on pages 3 to 6. Make sure that you fully understand the features, adjustments and capabilities of the machine that are outlined throughout this manual.

DRILL BIT SPEED CHART

WARNING: Operating speeds shown are maximum recommended RPM speeds for the drilling of various materials using different drill bits and sizes. Slower speeds than those listed may give better cutting action and results. Test drilling speeds on scrap material before final boring on projects.

	SOFTWOOD	HARDWOOD	ACRYLIC	BRASS	ALUMINUM	STEEL	SHOP NOTES
TWIST DRILL BITS							
1/16 - 3/16" / 1.59 - 4.76mm	3000	3000	2500	3000	3000	3000	Lubricate when cutting steel. Use a center punch to prevent bit from wandering when starting drilling.
1/4 - 3/8" / 6.35 - 9.53mm	3000	1500	2000	1200	2500	1000	
7/16 - 5/8" / 11.11 - 15.88mm	1500	750	1500	750	1500	500	
11/16 - 1" / 17.46 - 25.4mm	750	500	NR	400	1000	250	
BRAD-POINT BITS							
1/8" / 3.175mm	1800	1200	1500	NR	NR	NR	Raise bits often to clear shavings from flutes to prevent binding and heat buildup.
1/4" / 6.35mm	1800	1000	1500	NR	NR	NR	
3/8" / 9.525mm	1800	750	1500	NR	NR	NR	
1/2" / 12.7mm	1800	750	1000	NR	NR	NR	
5/8" / 15.875mm	1800	500	750	NR	NR	NR	
3/4" / 19.05mm	1400	250	750	NR	NR	NR	
7/8" / 22.225mm	1200	250	500	NR	NR	NR	
1" / 25.4mm	1000	250	200	NR	NR	NR	
FORSTNER BITS							
1/4 - 3/8" / 6.35 - 9.525mm	2400	700	250	NR	NR	NR	Raise bits often to clear shavings prevent binding and heat buildup. Make several shallow passes with larger bits to allow them to cool.
1/2 - 5/8" / 12.7 - 15.875mm	2400	500	250	NR	NR	NR	
3/4 - 1" / 19.05 - 25.4mm	1500	500	250	NR	NR	NR	
1-1/8 - 1-1/4" / 28.58 - 31.75mm	1000	250	250	NR	NR	NR	
1-3/8 - 2" / 34.93 - 50.8mm	500	250	NR	NR	NR	NR	
SPADE BITS							
1/4 - 1/2" / 6.35 - 12.7mm	2000	1500	NR	NR	NR	NR	Clamp work to table to prevent movement and improve the quality of the hole.
5/8 - 1" / 15.875 - 25.4mm	1750	1500	NR	NR	NR	NR	
1-1/8 - 1-1/2" / 28.58 - 30.48mm	1500	1000	NR	NR	NR	NR	
SPADE BITS WITH SPURS							
3/8 - 1" / 9.525 - 25.4mm	2000	1800	500	NR	NR	NR	Clamp work securely to table.
HOLE SAWS							
1 - 1-1/2" / 25.4 - 30.48mm	500	350	NR	250	250	NR	Do not use with brass or aluminum thicker than 1/16" (1.5mm). Avoid dense, resinous hardwoods.
1-5/8 - 2" / 41.275 - 50.8mm	500	250	NR	160	250	NR	
2-1/8 - 2-1/2" / 53.975 - 63.5mm	250	NR	NR	160	250	NR	
2-5/8 - 3"+ / 66.675 - 76.2mm+	100	NR	NR	100	100	NR	
CIRCLE CUTTERS							
1-1/2 - 3" / 30.48 - 76.2mm	500	250	250	NR	NR	NR	Drill one side, then flip material over to finish the cut.
3-1/4 - 6" / 82.55 - 152.4mm	250	250	250	NR	NR	NR	

Consult the drill bit manufacturer's recommendations for the proper use of the drill bits for the boring of materials and RPM speeds.

* Always wear safety glasses or face shield when drilling

* Reduce speed when drilling into wood end grain

* Clamp material to drill press tables to avoid movement and improve hole quality

* Use backup material when boring through material to prevent chip out

NR = Not Recommended for this material

MAINTENANCE

⚠ WARNING: Turn the power switch “OFF” and disconnect the plug from the outlet prior to adjusting or maintaining the machine. DO NOT attempt to repair or maintain the electrical components of the motor. Contact a qualified service technician for this type of maintenance.

1. Before each use:

- Check the power cord and plug for any wear or damage.
- Check for any loose screws, hardware or parts.
- Check the area to make sure it is clear of any misplaced tools, lumber, cleaning supplies, etc. that could hamper the safe operation of the machine.

2. To avoid a build-up of wood dust, regularly clean all parts of the machine using a soft cloth, brush or compressed air. A general cleaning should be done after every use to avoid future problems and ensure the machine is in ready condition for its next use.

WARNING: If blowing sawdust, wear proper eye protection to prevent debris from blowing into eyes.

3. Keep the machined surfaces of the drill press table and base free of resin and rust. Clean them regularly with a non-flammable solvent, then coat with a light film of dry lubricant spray or wax.

4. Lubricate the table bracket and locking lever bolts to keep them operating smoothly.

5. Clean the column on a regular basis to prevent the build-up of dust, drilling residue and rust. Treat the posts with a dry lubricant spray or a light coating of wax. Do not use ordinary oil which will collect dust and hamper the movement of parts along the column.

6. Periodically, lower the quill assembly and apply a light coating of machine oil to the quill and spindle surfaces. Raise and lower the quill a few times to distribute the oil on all of the internal surfaces.

7. Apply #2 tube grease to the worm gears in the table elevation mechanism and rack to keep them operating smoothly.

8. The ball bearings in the spindle and pulley assemblies are lifetime lubricated, sealed, and do not need any further care.

9. Keep the drive belt and pulley surfaces free of oil and grease. Periodically, check the drive belt for wear and replace if necessary.

CHANGING THE DRIVE BELT

1. Turn on the drill press and adjust the spindle speed to the lowest speed setting, in either the low range 700 RPM or the high range 2,800 RPM. This sets the gear plates high up on their spindles. See page 14 for Adjusting Drill Speeds.

2. Turn the machine OFF and disconnect it from the power source.

3. Loosen the belt tension by moving the motor closer to the head casting. Loosen the two Lock Knobs (#67) and with 16mm wrench turn the motor plate's leveling Bolt (#137) clockwise towards the motor. Then pull the Tension Lever (#89) forward to shift the motor mount assembly forward.

4. Open the top lid to access the drive belts. Remove the large, front V-Belt (#106, Fig. 28, A). This is done by first removing the top, Moveable Pulley (#114, B) from the center Pulley Shaft (#100). Loosen the Hex Screw (#115) on the pulley, and slowly lift the pulley off of the shaft - Spring #112 is under the top pulley plates and may pop these off !

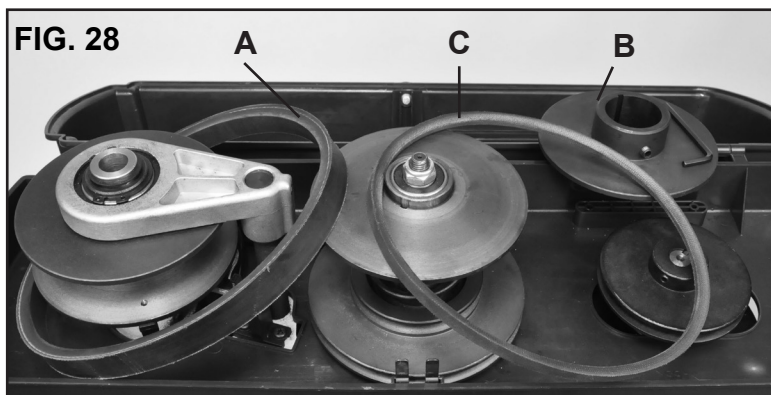

5. Work the front, large drive belt (A) up and off of the center shaft and lay it aside to re-install later.

6. Remove the rear Drive V-Belt (#80, Fig. 28, C) from the rear pulley and center shaft.

7. Replace the belts by reversing the process.

NOTE: When replacing the top, center pulley, make sure to align the key way with the key (#103) on the pulley shaft. Push the motor pulley down with 2 hands to compress the lower spring (#112) and position the pulley down on the shaft as far as possible, then tighten the hex screw to secure it in position.

WIRING DIAGRAM



WARNING:

This machine must be grounded. Replacement of the power supply cable should only be done by a qualified electrician. See page 5 for additional electrical information.

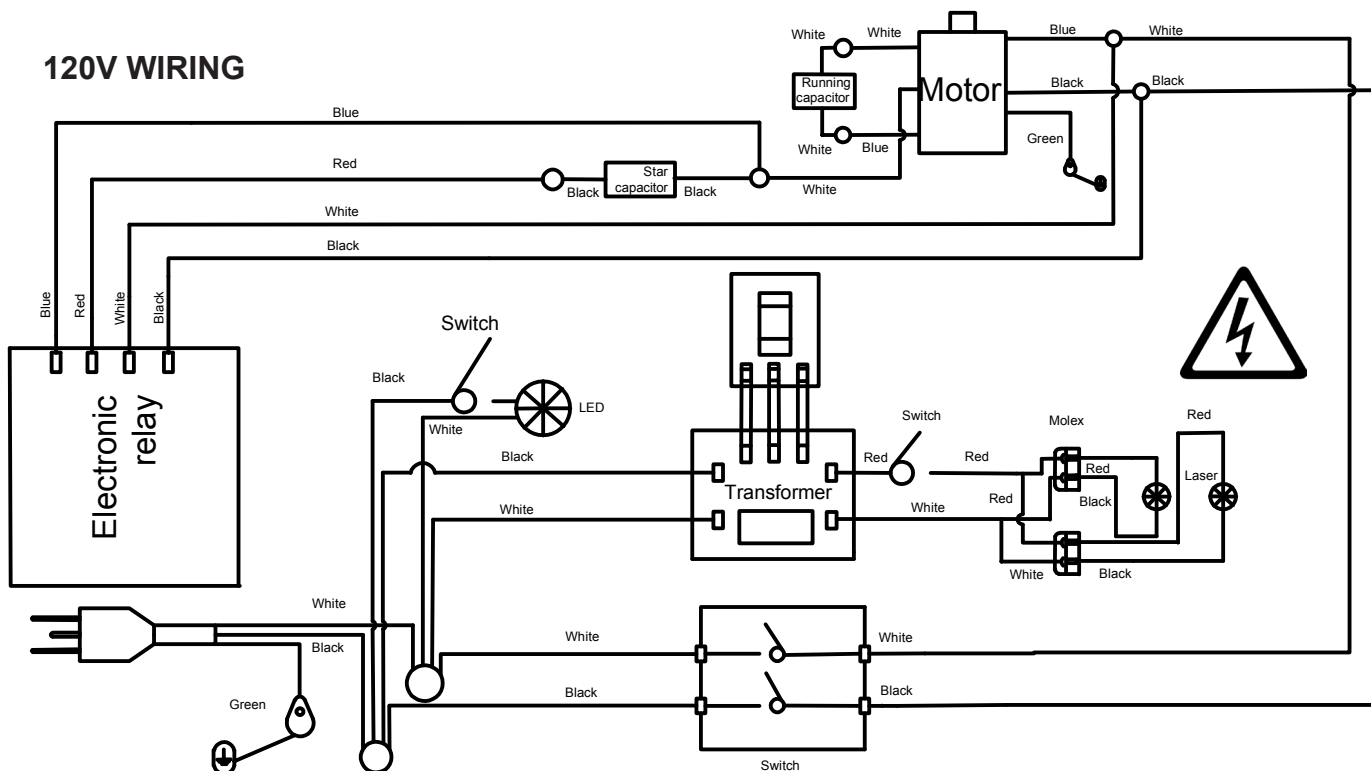

TROUBLESHOOTING

PROBLEM	PROBABLE CAUSE	REMEDY
Motor will not start	<ol style="list-style-type: none"> 1. Machine is not plugged in 2. Low line voltage 3. Loose connection 4. Defective switch 5. Defective motor capacitor 6. Starting at highest RPM speed position 	<ol style="list-style-type: none"> 1. Plug in machine 2. Check fuses or reset circuit breaker, if using extension cord, discontinue and plug machine directly into wall outlet 3. Check plug and all connections 4. Replace switch 5. Replace capacitor 6. Change belt to low RPM speed position
Motor fails to develop full power.	<ol style="list-style-type: none"> 1. Power line is overloaded 2. Undersize wires in supply system 3. Drive belt tension is too high 4. Low line voltage 5. Motor malfunctioning 	<ol style="list-style-type: none"> 1. Correct the overload condition 2. Increase supply wire size or eliminate using an extension cord 3. Adjust belt tension 4. Have voltage checked by an electrician and corrected, if necessary 5. Test motor to fix or replace
Motor stalls	<ol style="list-style-type: none"> 1. Overfeeding of drill bit into material 2. Dull drill bit 3. Motor malfunction, not reaching speed 	<ol style="list-style-type: none"> 1. Slower feed rate of the bit into material 2. Sharpen or replace drill bit 3. Check motor capacitor and line voltage
Motor overheats	<ol style="list-style-type: none"> 1. Motor is overloaded 2. Air flow restricted on the motor 	<ol style="list-style-type: none"> 1. Reduce load, slow down feed rate 2. Clean motor to increase air flow
Digital readout does not work	<ol style="list-style-type: none"> 1. Digital readout sensor out of position 	<ol style="list-style-type: none"> 1. Contact Technical Support at 877-884-5167 or email RIKON at techsupport@rikontools.com

TROUBLESHOOTING



WARNING

FOR YOUR OWN SAFETY, ALWAYS TURN OFF AND UNPLUG THE MACHINE BEFORE CARRYING OUT ANY TROUBLESHOOTING.

PROBLEM	PROBABLE CAUSE	REMEDY
Noisy operation	<ol style="list-style-type: none"> 1. Excessive machine vibration 2. Dry spindle 3. Loose pulleys 4. Noisy motor 	<ol style="list-style-type: none"> 1. Tighten any loose parts. Secure drill press to the floor or plywood base 2. Lubricate spindle, quill, etc. 3. Make needed corrections 4. Check motor bearings and fan
Drill bit or material smokes or burns	<ol style="list-style-type: none"> 1. Drilling speed is too fast 2. Chips are not clearing out of hole 3. Dull drill bit 4. Feeding bit is too slow 5. Bit is not lubricated 	<ol style="list-style-type: none"> 1. Reduce drilling speed 2. Retract drill bit frequently to clear chips 3. Change or sharpen drill bit 4. Increase feed speed 5. Lubricate bit. Make sure bit and flutes are clean of rust, resin build-up, etc.
Drill bit wanders or wobbles	<ol style="list-style-type: none"> 1. Bit not installed correctly in the chuck 2. Bit sharpened incorrectly 3. Bit is bent or shank is damaged 	<ol style="list-style-type: none"> 1. Re-install bit in chuck jaws correctly 2. Sharpen bit correctly or replace bit 3. Replace bit
Drill bit binds in the work piece	<ol style="list-style-type: none"> 1. Work piece is pinching the drill bit 2. Excessive feed rate 3. Chuck jaws are not holding bit tight 	<ol style="list-style-type: none"> 1. Support or clamp down the work piece 2. Slow down the feed rate 3. Tighten the chuck jaws on the bit
Drill bit slips	<ol style="list-style-type: none"> 1. Bit not installed securely in the chuck 	<ol style="list-style-type: none"> 1. Re-install the bit tightly in the chuck
Wood splinters on the underside of work piece	<ol style="list-style-type: none"> 1. No supporting 'back up material' under the work piece 	<ol style="list-style-type: none"> 1. Use scrap board or plywood under the work piece for support when the drill bit bores through the work
Work piece turns loose during drilling	<ol style="list-style-type: none"> 1. Work piece is not supported or clamped securely to the table 	<ol style="list-style-type: none"> 1. Support the work piece or clamp it securely to the drill press table
Quill returns too slow or too fast	<ol style="list-style-type: none"> 1. Spindle return spring has improper tension 	<ol style="list-style-type: none"> 1. Adjust spindle return spring tension
Chuck will not stay attached to the spindle	<ol style="list-style-type: none"> 1. Grease, oil or dirt is on the inside taper of the chuck or on the spindle taper 	<ol style="list-style-type: none"> 1. Clean the tapered surfaces of the chuck and spindle to remove residue

REPLACING THE LASERS

The wiring for the two XY LASER Pointers have been improved to now include Molex® connectors. These quick-release fasteners will permit easy repairs if, for any reason, there are any laser failures.

See page 16 for information on operating the lasers.

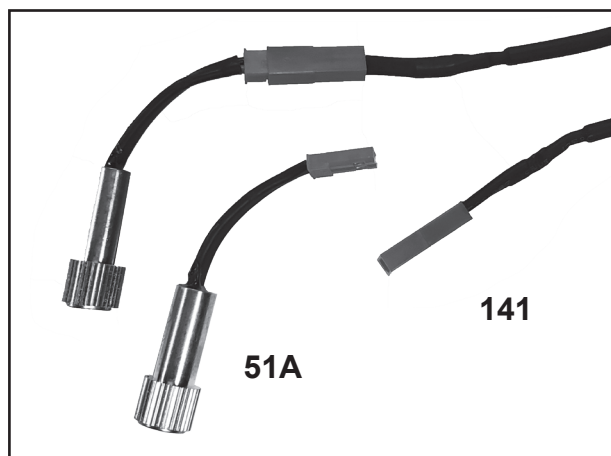

PARTS DIAGRAM

#30-212VS 12" Drill Press

NOTE: Please reference the Manufacturer's Part Number when calling for Replacement Parts. For Parts under Warranty, the Serial Number of your machine is required.

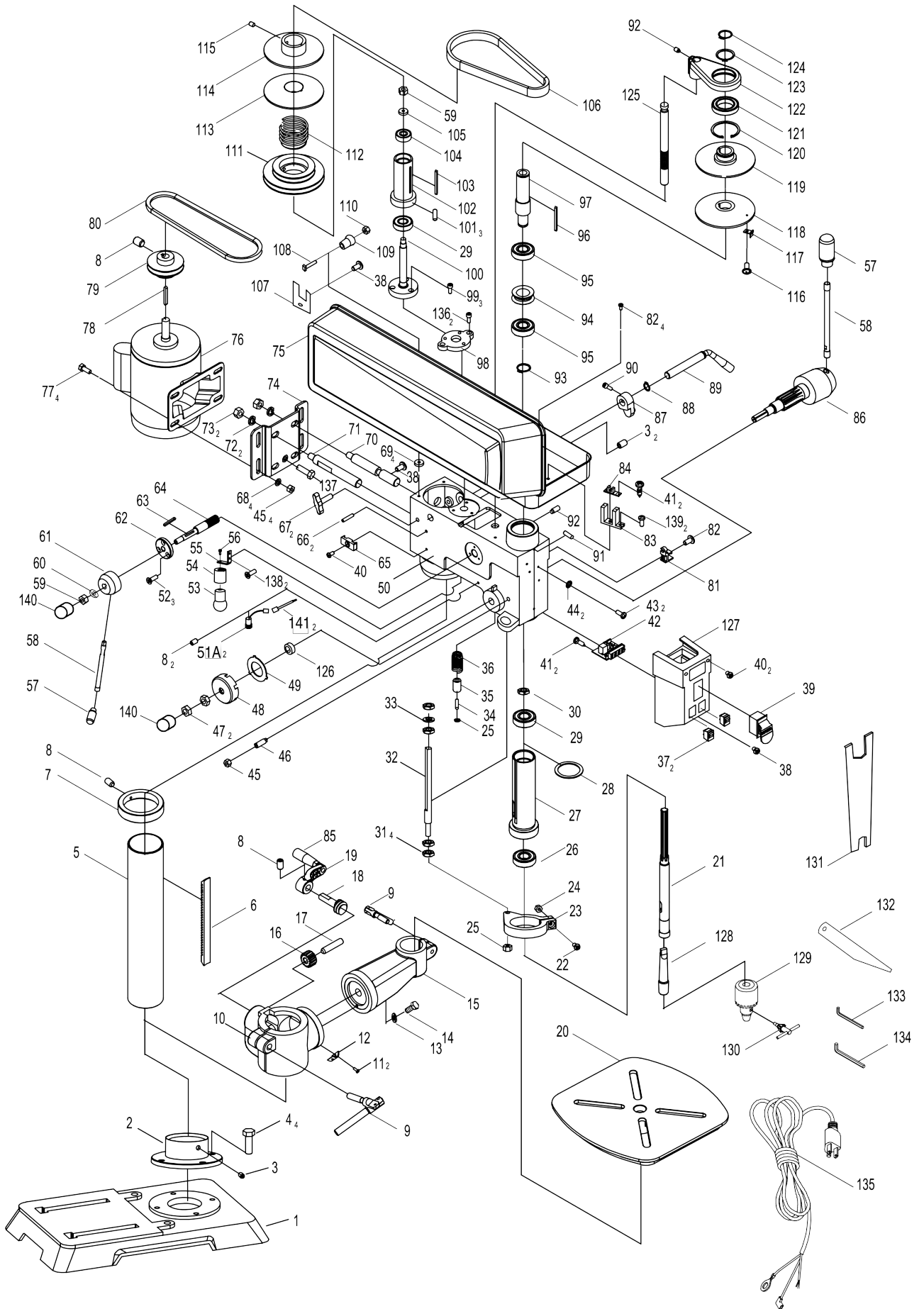

PARTS LIST

KEY NO.	DESCRIPTION	PART NO.	QTY.
1	Base	P30-212VS-1	1
2	Support Column	P30-212VS-2	1
3	Hex Screw M8x8	P30-212VS-3	3
4	Hex Bolt M10x25	P30-212VS-4	4
5	Column	P30-212VS-5	1
6	Rack	P30-212VS-6	1
7	Collar	P30-212VS-7	1
8	Hex Screw M6x0	P30-212VS-8	5
9	Table Handle	P30-212VS-9	2
10	Table Bracket	P30-212VS-10	1
11	Phillips Screw+spring washer+flat washer M4x8	P30-212VS-11	2
12	Pointer	P30-212VS-12	1
13	Spring Washer ϕ 12	P30-212VS-13	1
14	Hex Bolt M12x35	P30-212VS-14	1
15	Table Arm	P30-212VS-15	1
16	Helical Gear	P30-212VS-16	1
17	Gear Pin	P30-212VS-17	1
18	Worm Shaft	P30-212VS-18	1
19	Crank Handle	P30-212VS-19	1
20	Table	P30-212VS-20	1
21	Spindle	P30-212VS-21	1
22	Phillips Screw M6x16	P30-212VS-22	1
23	Lock Collar	P30-212VS-23	1
24	Hex Nut M6	P30-212VS-24	1
25	Hex Flange Nut M8	P30-212VS-25	2
26	Ball Bearing 6204RZ	P30-212VS-26	1
27	Quill	P30-212VS-27	1
28	Rubber Washer	P30-212VS-28	1
29	Ball Bearing 6002	P30-212VS-29	2
30	Hex Nut M14x1.5	P30-212VS-30	1
31	Nut	P30-212VS-31	4
32	Scale Label	P30-212VS-32	1
33	Special Washer	P30-212VS-33	1
34	Hex Screw M8X60	P30-212VS-34	1
35	Rack Adjustable Sleeve	P30-212VS-35	1
36	Rack Compression Spring	P30-212VS-36	1
37	Laser Switch	P30-212VS-37	2
38	Phillips Screw M5x10	P30-212VS-38	3
39	Switch	P30-212VS-39	1
40	Phillips Screw M5x12	P30-212VS-40	3
41	Phillips Screw ST2.9X6.5	P30-212VS-41	4
42	Digital Readout Transformer 120V - 3.5V/2W	P30-212VS-42	1
43	Phillips Screw+spring washer+flat washer M5x8	P30-212VS-43	2
44	Outer Teeth Washer ϕ 5	P30-212VS-44	2
45	Hex Nut M8	P30-212VS-45	5
46	Quill Set Screw M8	P30-212VS-46	1

SEE PAGES 24 & 25 FOR A CONTINUATION OF #30-212VS PART NUMBERS

PARTS LIST

KEY NO.	DESCRIPTION	PART NO.	QTY.
47	Hex Thin Nut M12	P30-212VS-47	2
48	Spring Cap Assembly	P30-212VS-48	1
49	Spring Block	P30-212VS-49	1
50	Head	P30-212VS-50	1
51A	Laser	P30-212VS-51A	2
52	Phillips screw M5x10	P30-212VS-52	3
53	LED Light Bulb 120V / 1.3W	P30-212VS-53	1
54	Bulb Socket	P30-212VS-54	1
55	Bulb Holder	P30-212VS-55	1
56	Phillips Screw M3x10	P30-212VS-56	1
57	Handle Knob	P30-212VS-57	4
58	Speed Control Handle	P30-212VS-58	1
59	Locking Nut M10	P30-212VS-59	2
60	Spring ϕ 10	P30-212VS-60	1
61	Variable	P30-212VS-61	1
62	Gear Base	P30-212VS-62	1
63	Key	P30-212VS-63	1
64	Gear Shaft	P30-212VS-64	1
65	Power Cord Clip	P30-212VS-65	1
66	Spring Pin 6x15	P30-212VS-66	2
67	Motor Lock Knob M8x20	P30-212VS-67	2
68	Flat Washer ϕ 8	P30-212VS-68	4
69	Bushing	P30-212VS-69	4
70	Motor Handle 1	P30-212VS-70	1
71	Motor Handle 2	P30-212VS-71	1
72	Spring Washer ϕ 10	P30-212VS-72	2
73	Hex Nut M10	P30-212VS-73	2
74	Motor Plate	P30-212VS-74	1
75	Pulley Cover Assembly	P30-212VS-75	1
76	Motor	P30-212VS-76	1
77	Hex Screw M8x16	P30-212VS-77	4
78	Key A4x4x40	P30-212VS-78	1
79	Motor Pulley	P30-212VS-79	1
80	V-Belt K24	P30-212VS-80	1
81	Wrench Bracket	P30-212VS-81	1
82	Hex Screw M6x12	P30-212VS-82	5
83	Counter Base	P30-212VS-83	1
84	Counter	P30-212VS-84	1
85	Handle	P30-212VS-85	1
86	Handle	P30-212VS-86	1
87	Shifter Fork Assembly	P30-212VS-87	1
88	Washer ϕ 15	P30-212VS-88	1
89	Motor Tension Lever Handle 45	P30-212VS-89	1
90	Hex Screw M8x12	P30-212VS-90	1
91	Spring Pin ϕ 5x13	P30-212VS-91	1
92	Hex Screw M8x12	P30-212VS-92	2
93	Washer ϕ 25	P30-212VS-93	1

SEE PAGE 23 FOR A CONTINUATION OF #30-212VS PART NUMBERS

PARTS LIST

KEY NO.	DESCRIPTION	PART NO.	QTY.
94	Ring	P30-212VS-94	1
95	Ball Bearing 61905RZ	P30-212VS-95	2
96	Key A4x4x60	P30-212VS-96	1
97	Bushing	P30-212VS-97	1
98	Cam Base	P30-212VS-98	1
99	Hex Screw M6x16	P30-212VS-99	3
100	Cam Shaft 45	P30-212VS-100	1
101	Hex Screw M6x8	P30-212VS-101	3
102	Cam Bushing	P30-212VS-102	1
103	Key A4x4x66	P30-212VS-103	1
104	Ball Bearing 6201RZ	P30-212VS-104	1
105	Washer ϕ 10	P30-212VS-105	1
106	V-Belt	P30-212VS-106	1
107	Locking Plate	P30-212VS-107	1
108	Bolt M5x30	P30-212VS-108	1
109	Pulley Cover Knob	P30-212VS-109	1
110	Locking Nut M5	P30-212VS-110	1
111	Cam V-Belt	P30-212VS-111	1
112	Cam Compression Spring	P30-212VS-112	1
113	Motor Fixed Pulley	P30-212VS-113	1
114	Motor Moveable Pulley HT150	P30-212VS-114	1
115	Hex Screw M8x10	P30-212VS-115	1
116	Phillips Screw M4x7	P30-212VS-116	1
117	Counter Baffle	P30-212VS-117	1
118	Spindle Moveable Pulley	P30-212VS-118	1
119	Spindle Fixed Pulley	P30-212VS-119	1
120	Spring Washer ϕ 55	P30-212VS-120	1
121	Bearing 61907	P30-212VS-121	1
122	Adjusting Base	P30-212VS-122	1
123	Spring Washer ϕ 35	P30-212VS-123	1
124	Spring Washer ϕ 26	P30-212VS-124	1
125	Rack Shaft Q235	P30-212VS-125	1
126	Bushing	P30-212VS-126	1
127	Switch Box	P30-212VS-127	1
128	Chuck Spindle	P30-212VS-128	1
129	Chuck JT3 #1-16mm	P30-212VS-129	1
130	Chuck Key	P30-212VS-130	1
131	Special Wrench 19mm / 8mm	P30-212VS-131	1
131A	Wrench 16mm (not shown)	P30-212VS-131A	1
132	Drift Key	P30-212VS-132	1
133	Hex Wrench S3	P30-212VS-133	1
134	Hex Wrench S4x63	P30-212VS-134	1
135	Power Cord 3x18AWGx2.65m	P30-212VS-135	1
136	Phillips Screw M8x20	P30-212VS-136	2
137	Hex Bolt M10x20	P30-212VS-137	1
138	Phillips Screw M5x6	P30-212VS-138	2
139	Phillips Screw+flat washer assy M5x12	P30-212VS-139	2
140	Rubber Cap	P30-212VS-140	2
141	Laser Wiring Connector 24AWG	P30-212VS-141	2

ACCESSORIES & WARRANTY

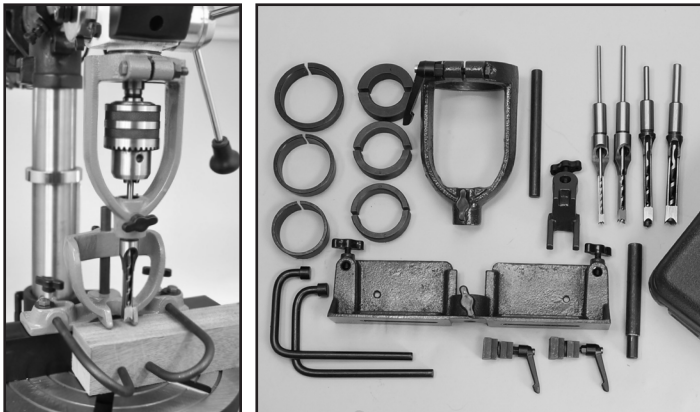

29-202 Mortising Attachment Kit

The Mortising Attachment converts your Drill Press in to an accurate mortising machine. It is ideal for drilling square holes for mortise & tenon joints that are commonly used in furniture, cabinets, sash, pattern shops and other woodworking plants.

The Mortising Attachment Kit can be installed on most any drill press with a collar size of: 40mm, 48mm, 50.8mm, 60mm, 66mm or 75mm. Kit includes yoke, collar adapters, fence, hold downs, 4 chisels & bits (1/4", 5/16", 3/8" 1/2") and plastic storage case.

NOTE: To attach the Mortising Kit's yoke and collar onto the 30-212VW drill press' quill, the drill's lock collar and depth scale assemblies (parts #23 ~ 33) need to be removed.

WARRANTY

RIKON POWER TOOLS®

5-Year Limited Warranty

RIKON Power Tools Inc. ("Seller") warrants to only the original retail consumer/purchaser of our products that each product be free from defects in materials and workmanship for a period of five (5) years from the date the product was purchased at retail. This warranty may not be transferred.

This warranty does not apply to defects due directly or indirectly to misuse, abuse, negligence, accidents, repairs, alterations, lack of maintenance or normal wear and tear. Under no circumstances will Seller be liable for incidental or consequential damages resulting from defective products. All other warranties, expressed or implied, whether of merchantability, fitness for purpose, or otherwise are expressly disclaimed by Seller. This five-year warranty does not cover products used for commercial, industrial or educational purposes. The warranty term for these claims will be limited to a two-year period.

This limited warranty does not apply to accessory items such as blades, drill bits, sanding discs, grinding wheels, belts, guide bearings and other related items.

Seller shall in no event be liable for death, injuries to persons or property, or for incidental, contingent, special, or consequential damages arising from the use of our products.

To take advantage of this warranty, proof of purchase documentation must be provided which has the date of purchase and an explanation of the complaint.

The Seller reserves the right to effect at any time, without prior notice, those alterations to parts, fittings, and accessory equipment which they may deem necessary for any reason whatsoever.

To register your machine online, visit RIKON at www.rikontools.com/warranty

To take advantage of this warranty, or if you have any questions, please contact us at 877-884-5167 or email warranty@rikontools.com



For more information:
25 Commerce Way
North Andover, MA 01845

877-884-5167 / 978-528-5380
techsupport@rikontools.com
parts@rikontools.com

Link to RIKON website

