

Air Filtration System 950CFM



Operator's Manual

Record the serial number and date of purchase in your manual for future reference.

Serial Number: _____ Date of purchase: _____

For technical support or parts questions, email techsupport@rikontools.com or call toll free at (877)884-5167

TABLE OF CONTENTS

| | |
|------------------------------------|---------|
| Specifications..... | 2 |
| Safety Instructions | 3 - 6 |
| Getting To Know Your Machine | 7 |
| Contents of Package | 7 - 8 |
| Installation | 8 |
| Assembly | 8 - 9 |
| Operation | 10 |
| Maintenance | 10 - 11 |
| Electricals & Wiring Diagram | 5 & 11 |
| Parts Diagram | 12 |
| Parts List | 13 |
| Troubleshooting | 14 |
| Accessories | 15 |
| Warranty | 15 |

SPECIFICATIONS

| | |
|-----------------------|------------------------------------|
| Model No. | 62-100 |
| Cubic Feet Per Minute | 950 CFM |
| Motor | 1/4 HP |
| Amps | 6 |
| Volts | 115V, 60 Hz |
| Speeds | 480, 750, or 950 CFM |
| Filter Size | 12" x 24" x 1" |
| Cabinet | 20 Gauge Steel |
| Blower Wheel Type | Steel |
| Blower Type | Squirrel Cage |
| Sound Rating on High | <74 dB |
| Filter (Microns) | Outer 5, Inner 1 |
| Timer | 2, 4, or 8 Hour Segments |
| Room Size - Per Hour | 20' x 20' x 8' - 14 Times Per Hour |
| Overall | |
| Length | 30-1/2" |
| Width | 25-1/2" |
| Height | 12-1/4" |
| Net Weight | 66 lbs. |
| Shipping Weight | 79 lbs. |
| Shipping Carton | 33-1/2" x 26" x 14-1/4" |
| Warranty | 5 Years |

This owner's manual is not a teaching aid and is intended to show assembly, adjustments, and general use.

SAVE THESE INSTRUCTIONS.

Refer to them often.

NOTE: The specifications, photographs, drawings and information in this manual represent the current model when the manual was prepared. Changes and improvements may be made at any time, with no obligation on the part of Rikon Power Tools, Inc. to modify previously delivered units. Reasonable care has been taken to ensure that the information in this manual is correct, to provide you with the guidelines for the proper safety, assembly and operation of this machine.

SAFETY INSTRUCTIONS

IMPORTANT! Safety is the single most important consideration in the operation of this equipment. **The following instructions must be followed at all times.** Failure to follow all instructions listed below may result in electric shock, fire, and/or serious personal injury.

There are certain applications for which this tool was designed. We strongly recommend that this tool not be modified and/or used for any other application other than that for which it was designed. If you have any questions about its application, do not use the tool until you have contacted us and we have advised you.

SAFETY SYMBOLS



SAFETY ALERT SYMBOL: Indicates DANGER, WARNING, or CAUTION. This symbol may be used in conjunction with other symbols or pictographs.



Indicates an imminently hazardous situation, which, if not avoided, could result in death or serious injury.



Indicates a potentially hazardous situation, which, if not avoided, could result in death or serious injury.



Indicates a potentially hazardous situation, which, if not avoided, could result in minor or moderate injury.

NOTICE: Shown without Safety Alert Symbol indicates a situation that may result in property damage.

GENERAL SAFETY

KNOW YOUR POWER TOOL. Read the owner's manual carefully. Learn the tool's applications, work capabilities, and its specific potential hazards.

BEFORE USING YOUR MACHINE

To avoid serious injury and damage to the tool, read and follow all of the Safety and Operating Instructions before operating the machine.

1. Some dust created by using power tools contains chemicals known to the State of California to cause cancer, birth defects, or other reproductive harm.

Some examples of these chemicals are:

- Lead from lead-based paints.
- Crystalline silica from bricks, cement, and other masonry products.
- Arsenic and chromium from chemically treated lumber.

Your risk from these exposures varies, depending on how often you do this type of work. To reduce your exposure to these chemicals: work in a well ventilated area and work with approved safety equipment, such as those dust masks that are specially designed to filter out microscopic particles.

2. **READ** the entire Owner's Manual. **LEARN** how to use the tool for its intended applications.

3. **GROUND ALL TOOLS.** If the tool is supplied with a 3 prong plug, it must be plugged into a 3-contact electrical receptacle. The 3rd prong is used to ground the tool and provide protection against accidental electric shock. **DO NOT** remove the 3rd prong. See Grounding Instructions on the following pages.

4. **AVOID A DANGEROUS WORKING ENVIRONMENT.** **DO NOT** use electrical tools in a damp environment or expose them to rain.

5. **DO NOT** use electrical tools in the presence of flammable liquids or gasses.

6. **ALWAYS** keep the work area clean, well lit, and organized. **DO NOT** work in an environment with floor surfaces that are slippery from debris, grease, and wax.

7. **KEEP VISITORS AND CHILDREN AWAY. DO NOT** permit people to be in the immediate work area, especially when the electrical tool is operating.

8. **DO NOT FORCE THE TOOL** to perform an operation for which it was not designed. It will do a safer and higher quality job by only performing operations for which the tool was intended.

9. **WEAR PROPER CLOTHING. DO NOT** wear loose clothing, gloves, neckties, or jewelry. These items can get caught in the machine during operations and pull the operator into the moving parts. The user must wear a protective cover on their hair, if the hair is long, to prevent it from contacting any moving parts.

10. **CHILDPROOF THE WORKSHOP AREA** by removing switch keys, unplugging tools from the electrical receptacles, and using padlocks.

11. **ALWAYS UNPLUG THE TOOL FROM THE ELECTRICAL RECEPTACLE** when making adjustments, changing parts or performing any maintenance.

SAFETY INSTRUCTIONS

12. KEEP PROTECTIVE GUARDS IN PLACE AND IN WORKING ORDER.

13. AVOID ACCIDENTAL STARTING. Make sure that the power switch is in the “OFF” position before plugging in the power cord to the electrical receptacle.

14. REMOVE ALL MAINTENANCE TOOLS from the immediate area prior to turning “ON” the machine.

15. USE ONLY RECOMMENDED ACCESSORIES. Use of incorrect or improper accessories could cause serious injury to the operator and cause damage to the tool. If in doubt, check the instruction manual that comes with that particular accessory.

16. NEVER LEAVE A RUNNING TOOL UNATTENDED. Turn the power switch to the “OFF” position. **DO NOT** leave the tool until it has come to a complete stop.

17. DO NOT STAND ON A TOOL. Serious injury could result if the tool tips over, or you accidentally contact the tool.

18. DO NOT store anything above or near the tool where anyone might try to stand on the tool to reach it.

19. MAINTAIN YOUR BALANCE. DO NOT extend yourself over the tool. Wear oil resistant rubber soled shoes. Keep floor clear of debris, grease, and wax.

20. MAINTAIN TOOLS WITH CARE. Always keep tools clean and in good working order. Keep all blades and tool bits sharp, dress grinding wheels and change other abrasive accessories when worn.

21. EACH AND EVERY TIME, CHECK FOR DAMAGED PARTS PRIOR TO USING THE TOOL. Carefully check all guards to see that they operate properly, are not damaged, and perform their intended functions. Check for alignment, binding or breaking of moving parts. A guard or other part that is damaged should be immediately repaired or replaced.

22. DO NOT OPERATE TOOL WHILE TIRED, OR UNDER THE INFLUENCE OF DRUGS, MEDICATION OR ALCOHOL.

23. SECURE ALL WORK. Use clamps or jigs to secure the workpiece. This is safer than attempting to hold the workpiece with your hands.

24. STAY ALERT, WATCH WHAT YOU ARE DOING, AND USE COMMON SENSE WHEN OPERATING A POWER TOOL.
A moment of inattention while operating power tools may result in serious personal injury.

25. ALWAYS WEAR A DUST MASK TO PREVENT INHALING DANGEROUS DUST OR AIRBORNE PARTICLES, including wood dust, crystalline silica dust and asbestos dust. Direct particles away from face and body. Always operate tool in well ventilated area and provide for proper dust removal. Use dust collection system wherever possible. Exposure to the dust may cause serious and permanent respiratory or other injury, including silicosis (a serious lung disease), cancer, and death. Avoid breathing the dust, and avoid prolonged contact with dust. Allowing dust to get into your mouth or eyes, or lay on your skin may promote absorption of harmful material. Always use properly fitting NIOSH/OSHA approved respiratory protection appropriate for the dust exposure, and wash exposed areas with soap and water.

26. USE A PROPER EXTENSION CORD IN GOOD CONDITION. When using an extension cord, be sure to use one heavy enough to carry the current your product will draw. The table on the following page shows the correct size to use depending on cord length and nameplate amperage rating. If in doubt, use the next heavier gauge. The smaller the gauge number, the larger diameter of the extension cord. If in doubt of the proper size of an extension cord, use a shorter and thicker cord. An undersized cord will cause a drop in line voltage resulting in a loss of power and overheating.
USE ONLY A 3-WIRE EXTENSION CORD THAT HAS A 3-PRONG GROUNDING PLUG AND A 3-POLE RECEPTACLE THAT ACCEPTS THE TOOL’S PLUG.

27. ADDITIONAL INFORMATION regarding the safe and proper operation of this product is available from:

- Power Tool Institute
1300 Summer Avenue
Cleveland, OH 44115-2851
www.powertoolinstitute.org
- National Safety Council
1121 Spring Lake Drive
Itasca, IL 60143-3201
www.nsc.org
- American National Standards Institute
25 West 43rd Street, 4th Floor
New York, NY 10036
www.ansi.org
- ANSI 01.1 Safety Requirements for Woodworking Machines and the U.S. Department of Labor regulations
www.osha.gov

28. SAVE THESE INSTRUCTIONS. Refer to them frequently and use them to instruct others.

SAFETY INSTRUCTIONS

ELECTRICAL SAFETY

⚠ WARNING: THIS TOOL MUST BE GROUNDED WHILE IN USE TO PROTECT THE OPERATOR FROM ELECTRIC SHOCK.

IN THE EVENT OF A MALFUNCTION OR BREAKDOWN, grounding provides the path of least resistance for electric current and reduces the risk of electric shock. This tool is equipped with an electric cord that has an equipment grounding conductor and requires a grounding plug (not included). The plug **MUST** be plugged into a matching electrical receptacle that is properly installed and grounded in accordance with **ALL** local codes and ordinances.

DO NOT MODIFY ANY PLUG. If it will not fit the electrical receptacle, have the proper electrical receptacle installed by a qualified electrician.

IMPROPER ELECTRICAL CONNECTION of the equipment grounding conductor can result in risk of electric shock. The conductor with the green insulation (with or without yellow stripes) is the equipment grounding conductor. **DO NOT** connect the equipment grounding conductor to a live terminal if repair or replacement of the electric cord or plug is necessary.

CHECK with a qualified electrician or service personnel if you do not completely understand the grounding instructions, or if you are not sure the tool is properly grounded when installing or replacing a plug.

USE ONLY A 3-WIRE EXTENSION CORD THAT HAS THE PROPER TYPE OF A 3-PRONG GROUNDING PLUG THAT MATCHES THE MACHINE'S 3-PRONG PLUG AND ALSO THE 3-POLE RECEPTACLE THAT ACCEPTS THE TOOL'S PLUG. *

REPLACE A DAMAGED OR WORN CORD IMMEDIATELY.

This tool is intended for use on a circuit that has an electrical receptacle as shown in **FIGURE A**. It shows a 3-wire electrical plug and electrical receptacle that has a grounding conductor. If a properly grounded electrical receptacle is not available, an adapter as shown in **FIGURE B** can be used to temporarily connect this plug to a 2-contact ungrounded receptacle. The adapter has a rigid lug extending from it that **MUST** be connected to a permanent earth ground, such as a properly grounded receptacle box. **THIS ADAPTER IS PROHIBITED IN CANADA.**

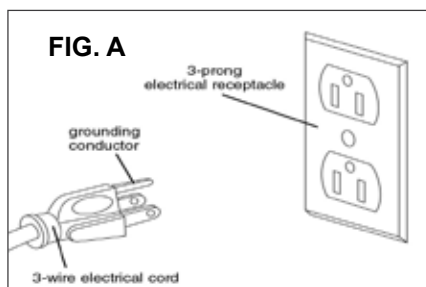

EXTENSION CORDS

⚠ WARNING: THE USE OF AN EXTENSION CORD WITH THIS MACHINE IS NOT RECOMMENDED. For best power and safety, plug the machine directly into a dedicated, grounded electrical outlet that is within the supplied cord length of the machine.

If an extension cord needs to be used, it should only be for a limited operation of the machine. The extension cord should be as short as possible in length, and have a minimum gauge size of 14AWG.

⚠ WARNING: Check extension cords before each use. If damaged replace immediately. Never use a tool with a damaged cord, since touching the damaged area could cause electrical shock, resulting in serious injury.

Use a proper extension cord. Only use cords listed by Underwriters Laboratories (UL). Other extension cords can cause a drop in line voltage, resulting in a loss of power and overheating of tool. When operating a power tool outdoors, use an outdoor extension cord marked "W-A" or "W". These cords are rated for outdoor use and reduce the risk of electric shock.

| MINIMUM RECOMMENDED GAUGE FOR EXTENSION CORDS (AWG) | | | | |
|---|----------|----------|-----------|-----------|
| 120 VOLT OPERATION ONLY | | | | |
| | 25' LONG | 50' LONG | 100' LONG | 150' LONG |
| 0 to 6 Amps | 18 AWG | 16 AWG | 16 AWG | 14 AWG |
| 6 to 10 Amps | 18 AWG | 16 AWG | 14 AWG | 12 AWG |
| 10 to 12 Amps | 16 AWG | 16 AWG | 14 AWG | 12 AWG |

⚠ WARNING: Keep the extension cord clear of the working area. Position the cord so that it will not get caught on lumber, tools or other obstructions while you are working with your power tool.

- * Canadian electrical codes require extension cords to be certified SJT type or better.
- ** The use of an adapter in Canada is not acceptable.

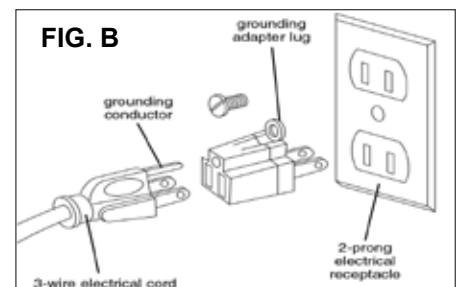

SAFETY INSTRUCTIONS

SPECIFIC SAFETY INSTRUCTIONS FOR AIR FILTRATION SYSTEMS

This machine is intended for the capture of airbourn particles to keep the air clean in your woodworking shop. The permissible room dimensions must be observed (see Technical Specification). Any other use not as specified, including modification of the machine or use of parts not tested and approved by the equipment manufacturer can cause unforeseen damage.

ATTENTION: Use of this air filtration system still presents risks that cannot be eliminated by the manufacturer. Therefore, the user must be aware that all machines are dangerous if not used with care, and all safety precautions are adhered to.

1. Do not operate this machine until you have read all of the following instructions.
2. Do not attempt to operate this machine until it is completely assembled.
3. Do not turn ON this machine if any pieces are missing.
4. If you are not familiar with the operation of the machine, obtain assistance from a qualified person.
5. Make sure that the System is secured in a horizontal position, if hanging from the ceiling or positioned on a work surface.
6. Do not place the System near an open ignition source - open flames, pilot lights, or grinding areas producing sparks.
7. Do not expose the System to rain or dampness.
8. Use the System for filtering wood dust only. Not for use filtering sheet rock dust, silica, lead paint dust, asbestos, biohazards, smoke, toxic fumes, spray paint or flammable liquids.
9. Do not use without the filters in place.
10. Never duct a machine directly into the air filtration system.
11. The use of any accessories or attachments not recommended may cause injury to you and damage your machine.
12. Do not leave the System running unattended.
13. Always make sure the power switch is in the OFF position prior to plugging in the machine.
14. Always disconnect (unplug) and make sure that the power switch is in the OFF position when doing any assembly, setup, or when cleaning or changing filters.
15. Always wear a dust mask when cleaning or working near a dust collector.
16. This machine must be properly grounded.
17. Always keep your face and hands clear of moving parts such as impellers and fans.
18. Keep these instructions for future reference.

This owner's manual is not a teaching aid and is intended to show assembly, adjustments, and general use.

CALIFORNIA PROPOSITION 65 WARNING: Some dust created by power sanding, sawing, grinding, drilling, and other construction activities contains chemicals known to the State of California to cause cancer and birth defects or other reproductive harm. Your risk from exposure to these chemicals varies, depending on how often you do this type of work. To reduce your exposure, work in a well-ventilated area and with approved safety equipment, such as dust masks that are specially designed to filter out microscopic particles.

For more detailed information about California Proposition 65, log onto rikontools.com.

GETTING TO KNOW YOUR AIR FILTRATION SYSTEM

Description

- A. Body
- B. Filter Holding Clips
- C. Outlet
- D. Control Panel & Receiver
- E. Power Cord
- F. Fuse
- G. Inlet Filters (2)
- H. Threads for Mounting Hanging Hardware

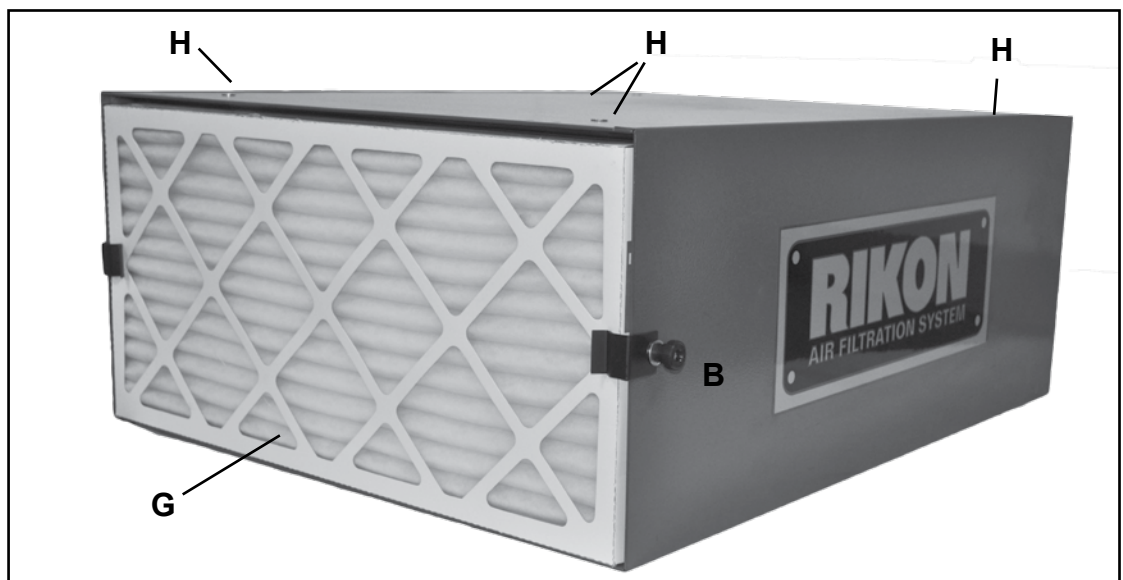
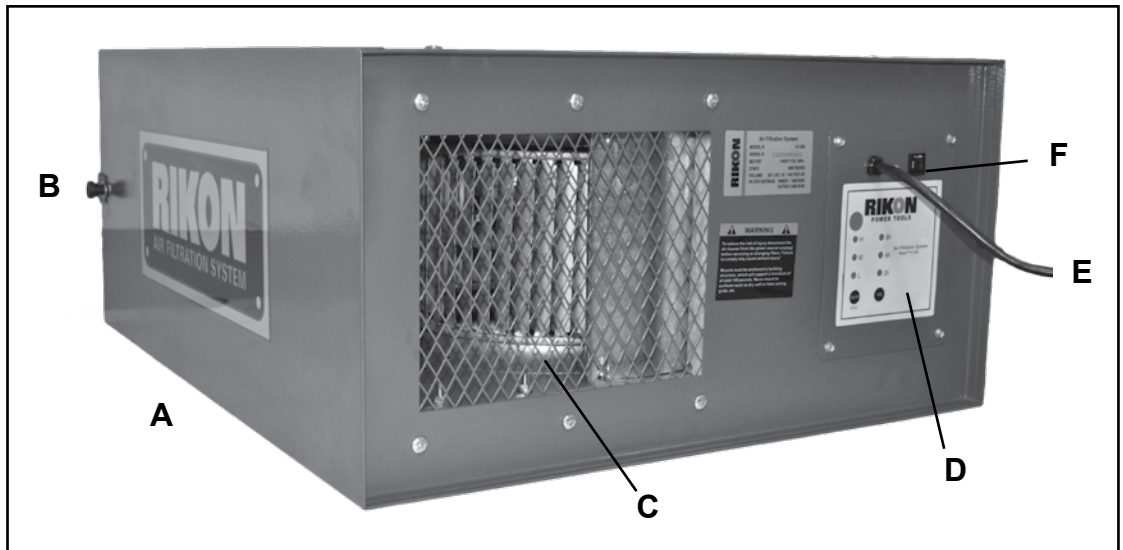

CONTENTS OF PACKAGE

Model 62-100 Air Filtration System is shipped complete in one box.

Unpacking and Clean-up

1. Carefully remove all contents from the shipping carton. Compare the contents with the list of contents to make sure that all of the items are accounted for, before discarding any packing material. Place parts on a protected surface for easy identification and assembly. If any parts are missing or broken, please call RIKON Customer Service (877-884-5167) as soon as possible for replacements. DO NOT turn your machine ON if any of these items are missing. You may cause injury to yourself or damage to the machine.
2. Report any shipping damage to your local distributor.
3. Clean any rust protected surfaces with ordinary house hold type grease or spot remover. Do not use; gasoline, paint thinner, mineral spirits, etc. These may damage painted surfaces.
4. Set the packing material and shipping carton aside. Do not discard these materials until the machine has been set up and is running properly. If there is an issue, the packing materials can be re-used for shipping purposes.

CONTENTS OF PACKAGE

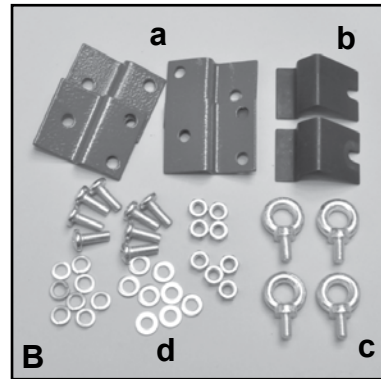

LIST OF LOOSE PARTS

- | | |
|---|--|
| <p>A. Air Filtration System</p> <ul style="list-style-type: none"> - Body - Outer Filter installed - Inner Filter installed - Motor & Squirrel Cage Assembly - Control Panel & Electricals | <p>B. Hardware Pack</p> <ul style="list-style-type: none"> a. Angle Brackets (4) b. Filter Holding Clips (2) c. Eyebolts (4) d. Screws, Washers & Nuts (8 ea.) <p>C. Remote Control</p> <p>D. Manual & Warranty Card</p> |
|---|--|

ASSEMBLY



THE MACHINE MUST NOT BE PLUGGED IN AND THE POWER SWITCH MUST BE IN THE 'OFF' POSITION UNTIL ASSEMBLY IS COMPLETE.

Tools Required for Assembly



#2 Phillips Screwdriver



10mm or an Adjustable Wrench

The air filter is designed to circulate air and filter wood and other non-metallic dust. The unit requires only minimal assembly. However, it is important to consider how and where to place the unit in your shop. When selecting a site, make sure there is a suitable power source.

Air Filtration System Placement:

The ideal location for an air filtration system is centered in the shop ceiling, mounted approximately 7-8 feet in the air away from corners, tall cabinets or heating/cooling vents that would restrict air flow. Another good location is above an area where a lot of sanding is done. Example; if you do lathe work and have a sanding center nearby, hang the air filtration unit between both areas. Depending on your shop size, you may need more than one air filtration system, or may have to choose a larger size. FIG. 1.

If hanging the unit is not an option, it can be mounted on a bench. Again, near an area that produces the most dust.

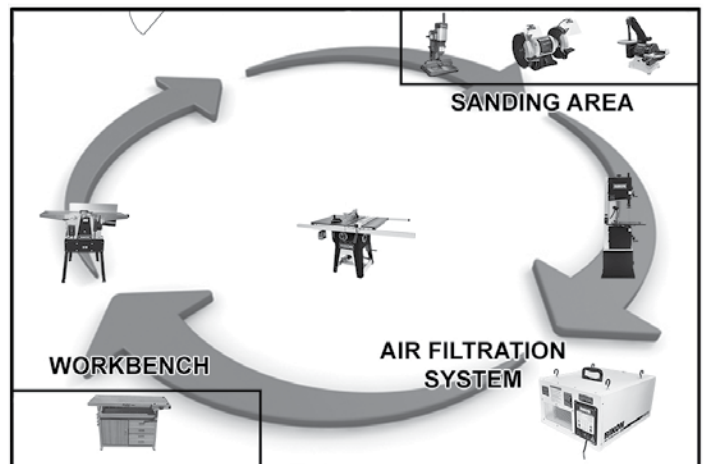

FIG. 1

ASSEMBLY

NOTE: Remove all packing and hardware from inside of the unit by removing the outer filter and inner filters.

INSTALL THE FILTER HOLDING CLIPS

1. Locate the two Filter Holding Clips in the hardware pack.
2. One end of the clips is slotted for easy installation and removal from the side knob assemblies that are on the two sides of the cabinet. FIG. 2.
3. Pull back the springs and slide the filter clips between the spring and the cabinet. The clips are now installed, and will hold the filters in place in the cabinet.



FIG. 2

MOUNTING THE SYSTEM TO THE CEILING

1. The air filtration unit can be hung from the ceiling. Hang the unit using the four eyebolts supplied with the System. The top of the cabinet has 4 pre-installed threaded nuts into which the eyebolts are screwed into (FIG. 3, A). Use extra heavy steel cable (as shown) or chain to suspend the unit to the ceiling joists.

NOTICE: Make sure the unit will be situated at least 7 feet (2.1 m) above the floor and at least 3 feet (1 m) away from a corner and from any heating or air vents.

2. Tighten each eyebolt into the cabinet top, securing the hanger in place.
3. Install the wood screw hooks (not supplied) into the building's wooden ceiling joists. Do not mount the air filter to non-structural surfaces such as dry wall or false ceiling grids. The hooks to hang this air filter system must be rated to support a maximum of 100 lbs (45 kg).
4. Mount the unit to the ceiling. Place a cable, or chain, on each ceiling hook and through the eyebolts.
5. Make sure the unit is level horizontally, and is at least 7 feet (2.1 m) above the floor. If it is not, remove the air filter and adjust the length of the cable or chain as needed. Then remount the unit.

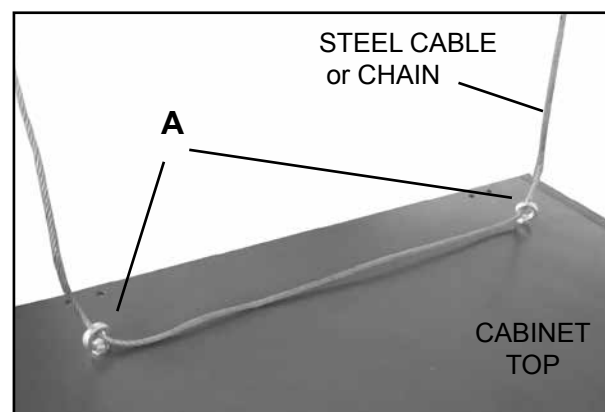

FIG. 3

6. Plug the air filter's power cord directly into a grounded power source.

NOTE: Four angle brackets can also be used for mounting to the ceiling, or wall.

1. Place one end of bracket underneath the lip of the cabinet. (clips in FIG. 4 are above the cabinet for clarity).
2. Attach the bracket (FIG. 4, A) with two Phillips head screws (B) and two lock washers & flat washers (C).
3. Repeat steps for remaining three brackets.

WARNING

Mounts must be anchored to building structure, which will support a minimum of at least 100 pounds. Never mount to surfaces such as dry wall or false ceiling grids, etc.

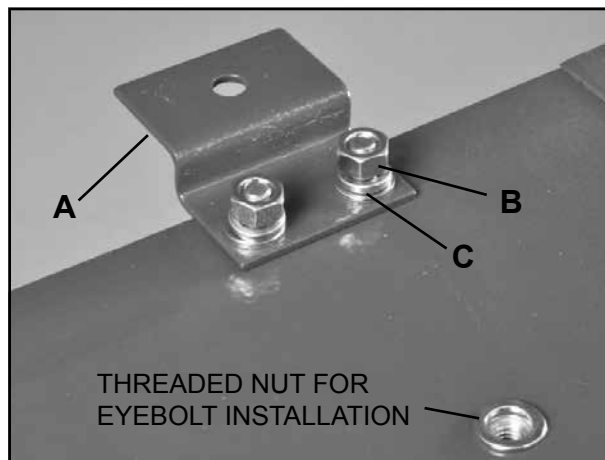

FIG. 4

OPERATION

The air filter can be operated directly using the control panel or with the remote control. Note: The remote control and control panel must be in direct view of each other for the infrared signals to work.

REMOTE CONTROL

1. The ON/OFF button (FIG. 5) turns the unit on and off. Pressing this button will start the fan on the low speed.
2. TIME button controls the three different settings.
 - 2H will light up on the back of the unit with one press of the time button. The air filtration system will operate for 2 hours then shut off.
 - 4H will light up on the back of the unit by pressing the time button twice. The air filtration system will operate for 4 hours then shut off.
 - 8H will light up on the back of the unit by pressing the time button three times. The air filtration system will operate for 8 hours then shut off.
3. SPEED button controls the three different settings - Low, Medium and High.

MANUAL CONTROL

The air filtration system can also be operated manually. The control panel, located at the outlet end of the unit, has the same functions as the remote control. FIG. 6:

- On/Off button (A)
- Time button (B)
- Speed button (A)

The Fuse switch (C) will pop out in case of overload. Wait 3-5 minutes before resetting the fuse switch.



FIG. 5

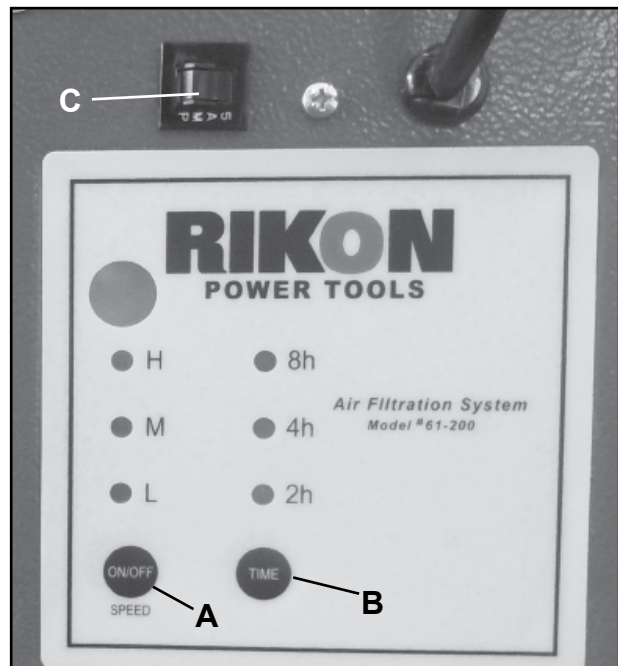

FIG. 6

MAINTENANCE

CHANGING THE FILTERS

Check the inner and outer filters periodically, depending on the amount of use, and change the filters when needed. Clogged filters will reduce the amount of air circulating through the filter.

1. The OUTER FILTER can be removed by disengaging the two filter clips (FIG. 7, A), then pull the filter out.
2. The INNER FILTER (FIG. 8) can now be pulled out of the unit. The inner filter can be blown out with air, or washed out to extend its life. Make sure the filter is completely dry before re-installing it in the cabinet.

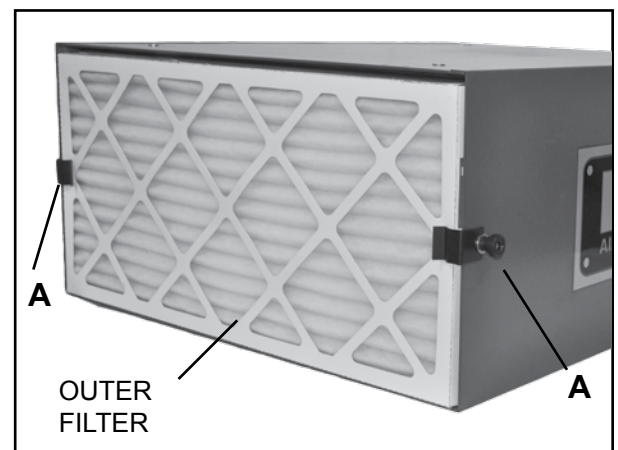

FIG. 7

MAINTENANCE

Continued from page 10;

3. The INNER FILTER's cloth bags must be positioned so they extend inside of the cabinet.
4. The OUTER FILTER has an arrow printed on the edge of the frame indicating the air flow direction. Make sure the filter is inserted facing the proper direction.
5. With both filters installed, re-position the two filter clips on either side of the cabinet to secure the filters in place.

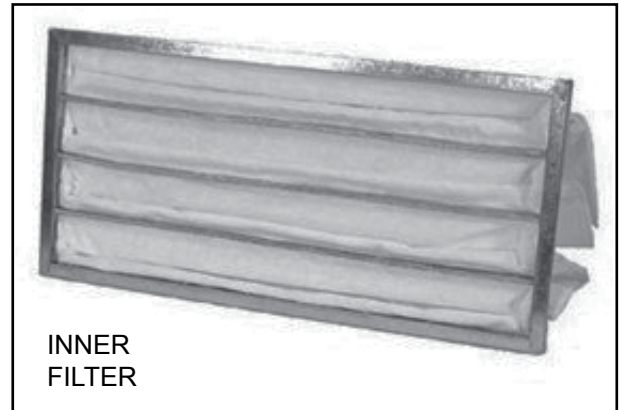

FIG. 8

! WARNING !

To reduce the risk of injury disconnect the air cleaner from the power source (unplug) before servicing or changing filters. Failure to comply may cause serious injury!

NOTE: Care should be taken when handling soiled or contaminated filters. As certain fine dusts can be harmful. Always wear a suitable mask for additional protection.

WIRING DIAGRAM



This machine must be grounded. Replacement of the power supply cable should only be done by a qualified electrician. See page 5 for additional electrical information.

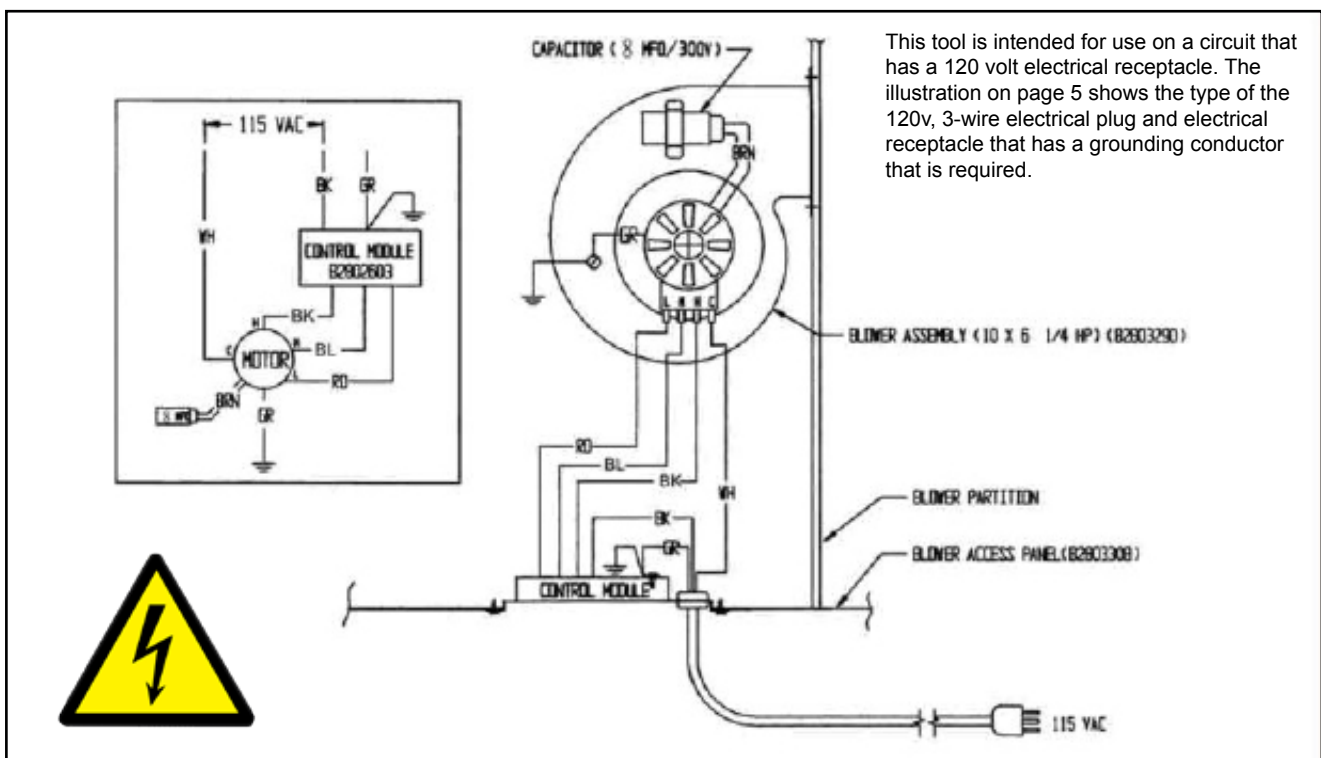

PARTS DIAGRAM

62-100 AIR FILTRATION SYSTEM

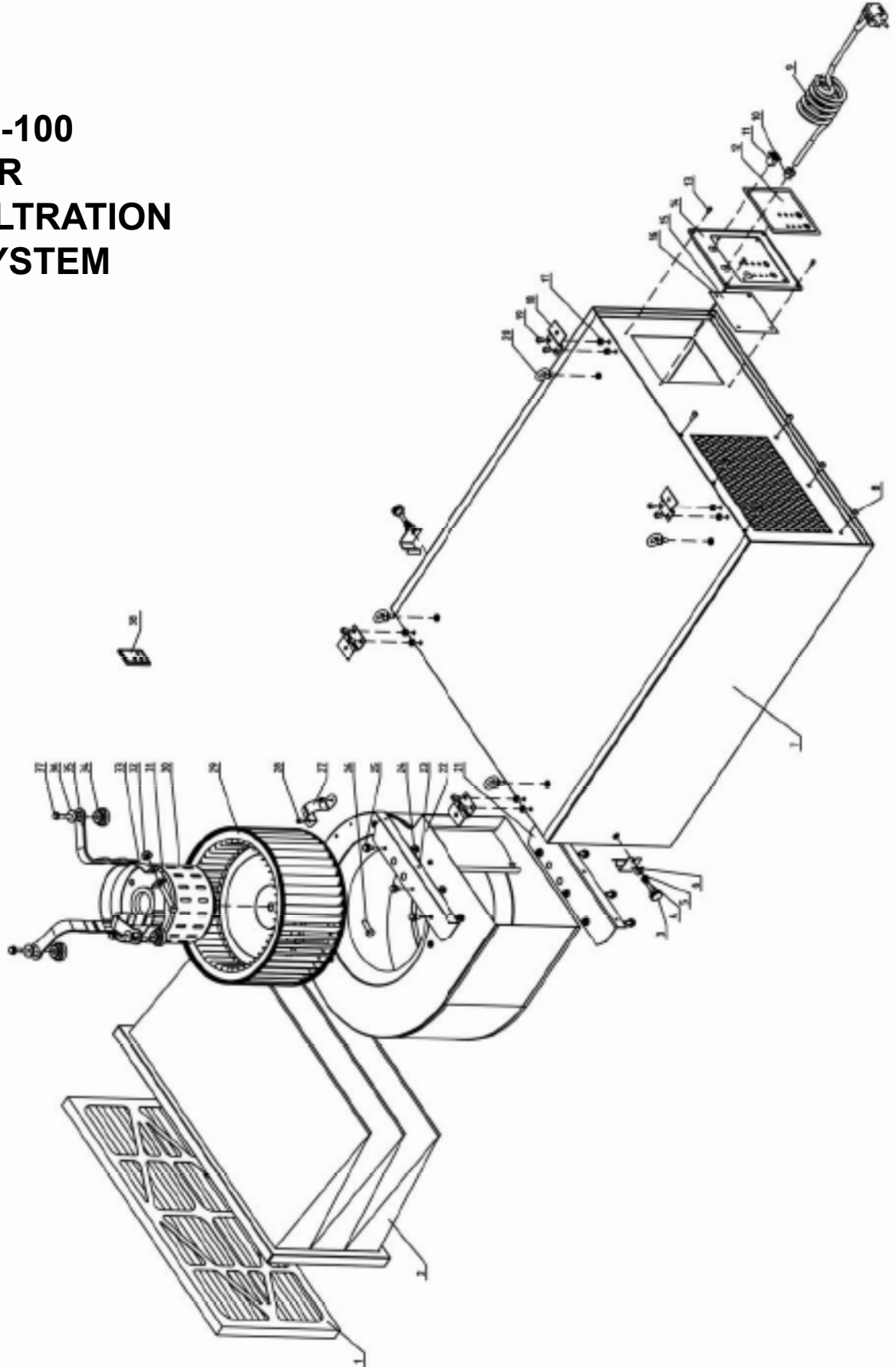

NOTE: Please reference the Manufacturer's Part Number when calling for Replacement Parts. For Parts under Warranty, the Serial Number of your machine is required.

PARTS LIST

| KEY NO. | DESCRIPTION | MFG. PART NO. | KEY NO. | DESCRIPTION | MFG. PART NO. |
|---------|---------------------------|---------------|---------|-------------------|---------------|
| 1 | Outer Filter | P61-200-1 | 20 | Hook | P61-200-20 |
| 2 | Inner Filter Bag | P61-200-2 | 21 | Fan Cover | P61-200-21 |
| 3 | Wing Nut | P61-200-3 | 22 | Fan Assembly | P61-200-22 |
| 4 | Spring | P61-200-4 | 23 | Fan Cover | P61-200-23 |
| 5 | Washer | P61-200-5 | 24 | Nut | P61-200-24 |
| 6 | Filter Holding Plate | P61-200-6 | 25 | Bolt | P61-200-25 |
| 7 | Body | P61-200-7 | 26 | Screw | P61-200-26 |
| 8 | Screw | P61-200-8 | 27 | Clip | P61-200-27 |
| 9 | Cord & Plug | P61-200-9 | 28 | Screw | P61-200-28 |
| 10 | Strain Relief Fitting | P61-200-10 | 29 | Fan | P61-200-29 |
| 11 | Fuse | P61-200-11 | 30 | Motor | P61-200-30 |
| 12 | Plate Cover | P61-200-12 | 30A | Motor Capacitor * | P61-200-30A |
| 13 | Screw | P61-200-13 | 31 | Screw | P61-200-31 |
| 14 | Plate | P61-200-14 | 32 | Nut | P61-200-32 |
| 15 | Circuit Board | P61-200-15 | 33 | Bracket Washer | P61-200-33 |
| 15A | Spacer for Outer Filter * | P61-200-15A | 34 | Motor Mat | P61-200-34 |
| 16 | Screw | P61-200-16 | 35 | Motor Bracket | P61-200-35 |
| 17 | Hook | P61-200-17 | 38 | Washer | P61-200-36 |
| 18 | Fastener | P61-200-18 | 37 | Screw | P61-200-37 |
| 19 | Screw | P61-200-19 | 38 | Remote Control | P61-200-38 |

* Not Shown in Parts Diagram

NOTE: Please reference the Manufacturer's Part Number when calling for Replacement Parts.
For Parts under Warranty, the Serial Number of your machine is required.

TROUBLESHOOTING

TO PREVENT INJURY TO YOURSELF or damage to the Air Filtration System, turn the switch to the machine “OFF” and unplug the power cord from the electrical receptacle before making any adjustments.

| PROBLEM | LIKELY CAUSE(S) | SOLUTION(S) |
|---|---|--|
| Motor does not run | <ol style="list-style-type: none"> 1. Machine not plugged in 2. Power switch in “OFF” position 3. Power switch or cord is faulty 4. Fuse or circuit breaker are open 5. Remote control is not working 6. Remote control batteries are dead 7. Infrared receiver is not working 8. Control panel ON/OFF button is not working 9. Control panel fuse is blown 10. Motor does not work | <ol style="list-style-type: none"> 1. Plug power cord into electrical receptacle 2. Lift switch to “ON” position 3. Replace switch or power cord 4. Overloaded electrical circuit 5. Point remote control directly at control panel <ul style="list-style-type: none"> - Make sure infrared sensor on the control panel is not blocked - Move remote control closer to the control panel for better direct infrared signal 6. Replace batteries. 7. Inspect or replace control panel circuit board 8. Inspect or replace control panel circuit board 9. Replace blown fuse, see page 13 for instruction 10. Replace motor |
| Motor stalls or does not have full power | <ol style="list-style-type: none"> 1. Incorrect line voltage 2. Motor capacitor has failed 3. Control panel circuit board has failed | <ol style="list-style-type: none"> 1. Have a qualified electrician check circuit for proper voltage 2. Replace the motor capacitor 3. Inspect or replace control panel circuit board |
| System has vibration or is noisy | <ol style="list-style-type: none"> 1. Motor or cabinet part is loose 2. Motor fan is rubbing cover 3. Motor bearings are loud 4. Air filters rattle 5. Impeller fan is loose, unbalanced or damaged 6. Motor base is loose in the cabinet | <ol style="list-style-type: none"> 1. Inspect all hardware and retighten or replace 2. Check position of the fan and cover, and adjust or replace any loose/damaged parts 3. Rotate motor shaft to isolate issue Replace worn bearings 4. Inspect and reposition filters 5. Turn machine off and unplug from power. <ul style="list-style-type: none"> - Inspect impeller for bent or damaged areas. - Secure impeller on motor shaft and replace if any damage is found 6. Tighten any loose fasteners |
| Poor air flow and dust collection | <ol style="list-style-type: none"> 1. Filters are dirty 2. Poor system location in shop | <ol style="list-style-type: none"> 1. Clean or replace both air filters frequently 2. Reposition system in the shop for best air circulation. Refer page 8 for proper air filtration system placement |

For parts or technical questions contact: techsupport@rikontools.com or 877-884-5167.

ACCESSORIES

61-911F OUTER FILTER - 5 Micron



61-905 INNER BAG FILTER - 1 Micron

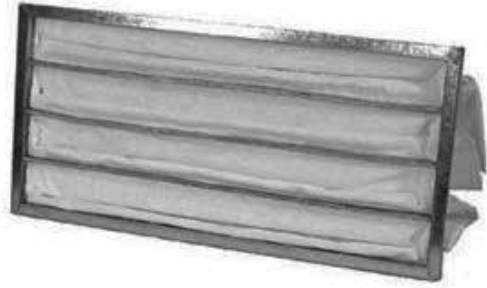

61-910C CHARCOAL FILTER - 5 Micron



61-912E ELECTROSTATIC FILTER - 1 Micron

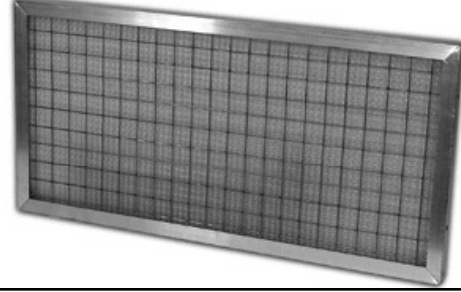

WARRANTY

RIKON
POWER TOOLS

5-Year Limited Warranty

RIKON Power Tools Inc. ("Seller") warrants to only the original retail consumer/purchaser of our products that each product be free from defects in materials and workmanship for a period of five (5) years from the date the product was purchased at retail. This warranty may not be transferred.

This warranty does not apply to defects due directly or indirectly to misuse, abuse, negligence, accidents, repairs, alterations, lack of maintenance or normal wear and tear. Under no circumstances will Seller be liable for incidental or consequential damages resulting from defective products. All other warranties, expressed or implied, whether of merchantability, fitness for purpose, or otherwise are expressly disclaimed by Seller. This warranty does not cover products used for commercial, industrial or educational purposes.

This limited warranty does not apply to accessory items such as blades, drill bits, sanding discs, grinding wheels or belts and other related items.

Seller shall in no event be liable for death, injuries to persons or property, or for incidental, contingent, special, or consequential damages arising from the use of our products.

To take advantage of this warranty proof of purchase documentation, which includes date of purchase and an explanation of the complaint, must be provided.

The Seller reserves the right to effect at any time, without prior notice, those alterations to parts, fittings, and accessory equipment which they may deem necessary for any reason whatsoever.

To take advantage of this warranty, please fill out the enclosed warranty card and send it to:
RIKON Warranty, 16 Progress Rd., Billerica, MA 01821

The card must be entirely completed in order for it to be valid. If you have any questions please contact us at 877-884-5167 or warranty@rikontools.com.



**For more information:
16 Progress Rd
Billerica, MA 01821**

**877-884-5167 / 978-528-5380
techsupport@rikontools.com**