

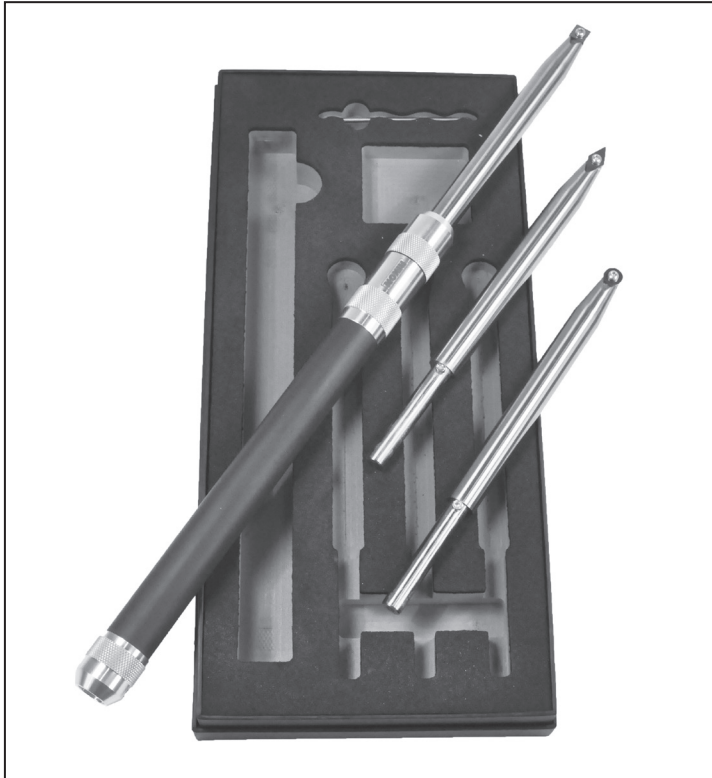

#70-800

4-Piece WOODTURNING SYSTEM with Carbide Insert Cutters



Developed for the experienced or novice wood turner, RIKON's turning system features tungsten carbide cutters that keep their sharp cutting edges longer than typical carbon or high speed steel tools. After hours and hours of use, if a cutter becomes dull, just rotate it to work with another new side of the edge. Changes only take seconds.

Set includes: 16" Handle, 3 Shafts with Round, Square and Diamond shaped tungsten carbide cutters, mounting screws and T20 star wrench.
All packaged in a presentation, storage box.

RIKON's #70-800 Woodturning System includes a 16" long, machined aluminum Handle with an anti-vibration grip and features a keyless chucking system for attaching the shafts with cutters to the handle. Simply unscrew the knurled chuck collet to insert any of the three supplied shafts with carbide cutters, tighten the chuck collar, and you are ready to turn! No tools are required!

Three, 8-3/8" steel Shafts are supplied along with Round, Square and Diamond shaped tungsten carbide Insert Cutters that are secured to the shafts' working end with a T20 screw.

USAGE NOTE: The finely machined shafts have bottoms that are milled with a flat, and 2 side bevels for extra stability on the tool rest when turning. The bottom flat is in line with the cutter to maintain the cutter in a flat position for scrape cutting. The two side bevel surfaces also give the user extra support when the cutter is shifted to an angled skew position for shear cutting action. Flats give the support and control needed, especially when turning bowl interiors where the cutter is extended out far from the tool rest.



TUNGSTEN CARBIDE INSERT CUTTERS

These long lasting, extremely hard cutters work through the hardest woods in either a scraping or shear cutting mode. Made of premium micrograin carbide, these inserts can be sharpened with diamond abrasives. Simply lap the entire TOP surface only to reveal a new cutting edge. Do not sharpen or change the angle of the bevel edge.

Some cutters may include a dot • on the top surface. This dot is simply a reference point to help users when rotating a cutter to a new setting if the working edge becomes dull.

NOTE: Carbide insert cutters are primarily used for the final shaping and detailing of turnings.

The variety of cutter shapes will provide you with many options for shaping and decorating your turnings. When used for roughing out blanks, this should be done with careful, slow cuts to avoid loosening the mounting screw or damaging the cutter from the heavy impacts that are encountered. The R2 Square Cutter 70-814 is the best shape for this work.

3 Insert Cutters included with the Set:



ROUND Insert Cutter - # 70-810

Very effective for finishing cuts on bowl interiors or any cove or contoured designs on bowls and spindles.

SQUARE Insert Cutter - # 70-811

Straight edges on this carbide cutter make it extremely useful for shaping convex or straight surfaces. Ideal for producing tenons for furniture construction. Reposition and use a corner for 90° V-cuts.

DIAMOND Insert Cutter - # 70-812

Mainly used to add thin line details on turnings, the spear-point tip is great for undercutting and creating small beads. The long sides of the cutter are also useful for fine shaping of rims on bowls or plates. Use carefully, as excessive pressure on the tip from hitting knots, irregular wood grain or aggressive use could damage the cutter.

ASSEMBLY

Install the Carbide Insert Cutters onto the working ends of the shafts with the supplied mounting screws and T20 star wrench. The cutter's relief bevel should be facing down. Do not over tighten the screws or damage to the cutters or screw threads may result.

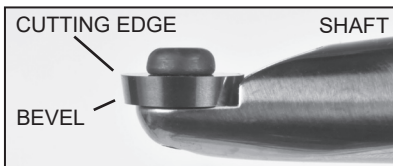

Some specialty cutters (Ex: 70-816 Fingernail or 70-817 Paisley Left) are designed to be mounted in various positions for turning interior relief or undercuts on bowls and platters (see below).

If cutters are set on an angle to the axis of the shaft, the use of the Side Handle 70-804 (sold separately) is recommended to better control the cutter from dipping during work.

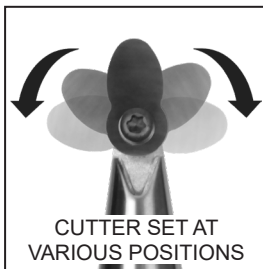
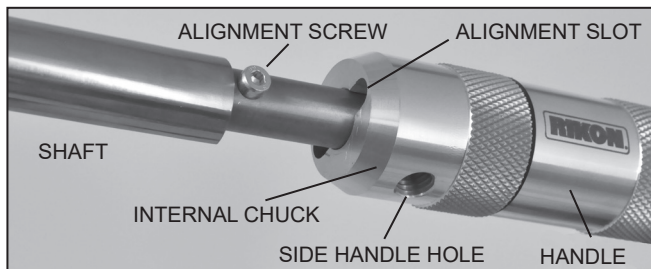

Install the Shaft into the turning handle.

The front of the handle features an internal compression chuck that securely attaches the shaft to the handle.

- 1 – Grasp the two knurled sections of the handle's front section and turn the forward chuck *counterclockwise* to loosen the chuck.
- 2 – Insert the rear, 14mm diameter end of the shaft into the handle. The shaft has an alignment screw that needs to be positioned into one of the slots milled into the forward nose of the handle.
- 3 – With the shaft fully inserted into the handle, turn the knurled forward chuck *clockwise* to secure the shaft in the handle.

MAINTENANCE

1. Keep cutters sharp. If an edge becomes dull, simply lap the entire TOP surface only on a diamond stone to reveal a new cutting edge. Do not sharpen or change the angle of the bevel edge.
2. Keep the threads clean on the mounting screws and tapped screw holes in the shafts. Remove any dust, resin or moisture buildup to ensure the mounting of the cutters are secure. Lightly grease or oil the screws and shafts to prevent rusting.
3. Clean all parts of the woodturning system after every use to avoid future problems and ensure the tools are ready for the next time they are used.
4. Do not use and replace any damaged parts to avoid possible injury while turning. RIKON will not issue replacements or refunds if products are damaged from improper use.

California Prop 65 Warning:

 **WARNING:** Drilling, sawing, sanding or machining wood products can expose you to wood dust, a substance known to the State of California to cause cancer. Avoid inhaling wood dust or use a dust mask or other safeguards for personal protection. For more information go to www.P65Warnings.ca.gov/wood.

Optional Accessories for use with the #70-800 Woodturning System

The 16" handle supplied in the set is hollow with a removable end cap. If a longer handle is desired for extra leverage when the cutter is extended out from the tool rest (typical use when turning bowl interiors), a separate **6" Handle Extension** is available. This short handle section screws into the rear of the 16" handle, then the end cap is re-installed onto the end of the extension.

Multiple 6" handle extensions can be used together to extend the 16" handle even further.

70-802

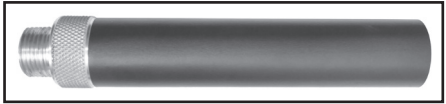

If extra weight in the handle is desired to counteract vibration and sudden yanks that are commonly experienced when turning, an optional solid steel **Counterweight** fits inside of the handle and is secured in place by the end cap. Lead pellets (buckshot) can also be used, as the handle cavity is sealed to prevent pellet spillage. 4-5/16" x 3/4", 9 ounces.

70-803



The 16" handle's chuck collar has a threaded side hole to install a **Side Handle** for extra holding stability, particularly when turning interiors of large bowls or platters. Pending how the shaft is installed in the chuck's forward alignment holes, the side handle can be positioned for left hand or right hand use. 5-1/4" x 13/16".

70-804

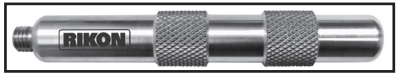

Optional Accessories:

- 70-801** 16" Handle
- 70-802** 6" Handle Extension
- 70-803** Counterweight 4-5/16" x 3/4"
- 70-804** Side Handle 5-1/4" x 13/16"
- 70-805** Shaft only (without cutter) 8-3/8"
- 70-807** Screw M4x10mm T20 for cutters 5mm thick
- 70-806** Screw M4x9mm T20 for cutters 3.2mm thick *
* indicated below

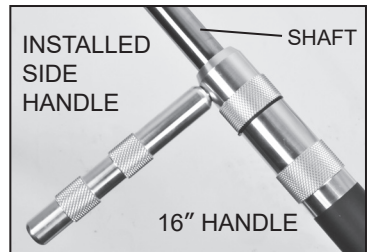

Carbide Insert Cutters:

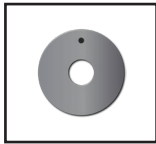

70-810
Round 14mm *

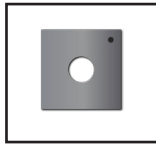

70-811
Square 13mm *

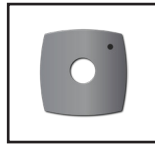

70-814
R2 Square 14mm *

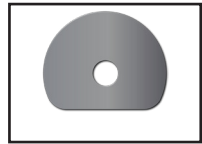

70-815
Semi-Circle 20mm

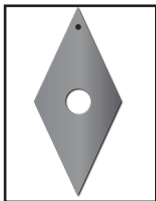

70-812
Diamond *



70-813
3/16" Radius

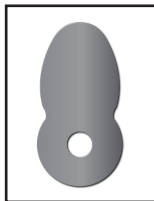

70-816
Fingernail

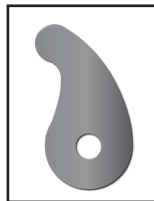

70-817
Paisley Left

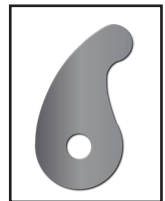

70-818
Paisley Right

For more information on new 70-800 cutters contact your local RIKON dealer, or visit:

RIKON Power Tools, Inc., Billerica, MA 01821
www.rikontools.com